

1.- RESULTADOS DEL CÁLCULO DE DEMANDA ENERGÉTICA.....	2
1.1.- DEMANDA ENERGÉTICA ANUAL POR SUPERFICIE ÚTIL.....	2
1.2.- RESUMEN DEL CÁLCULO DE LA DEMANDA ENERGÉTICA.....	2
1.3.- RESULTADOS MENSUALES.....	3
1.3.1.- BALANCE ENERGÉTICO ANUAL DEL EDIFICIO.....	3
1.3.2.- DEMANDA ENERGÉTICA MENSUAL DE CALEFACCIÓN Y REFRIGERACIÓN.....	4
1.3.3.- EVOLUCIÓN DE LA TEMPERATURA.....	5
1.3.4.- RESULTADOS NUMÉRICOS DEL BALANCE ENERGÉTICO POR ZONA Y MES.....	9
2.- MODELO DE CÁLCULO DEL EDIFICIO.....	14
2.1.- ZONIFICACIÓN CLIMÁTICA.....	14
2.2.- ZONIFICACIÓN DEL EDIFICIO, PERFIL DE USO Y NIVEL DE ACONDICIONAMIENTO.....	15
2.2.1.- AGRUPACIONES DE RECINTOS.....	15
2.2.2.- PERFILES DE USO UTILIZADOS.....	18
2.3.- DESCRIPCIÓN GEOMÉTRICA Y CONSTRUCTIVA DEL MODELO DE CÁLCULO.....	18
2.3.1.- COMPOSICIÓN CONSTRUCTIVA. ELEMENTOS CONSTRUCTIVOS PESADOS.....	18
2.3.2.- COMPOSICIÓN CONSTRUCTIVA. ELEMENTOS CONSTRUCTIVOS LIGEROS.....	26
2.3.3.- COMPOSICIÓN CONSTRUCTIVA. PUENTES TÉRMICOS.....	30
2.4.- PROCEDIMIENTO DE CÁLCULO DE LA DEMANDA ENERGÉTICA.....	32

# Justificación del cumplimiento de la exigencia básica HE 1: Limitación de demanda energética

## 1.- Resultados del cálculo de demanda energética.

### 1.1.- Demanda energética anual por superficie útil.

$$D_{cal,edificio} = 13.00 \text{ kWh}/(\text{m}^2 \cdot \text{año}) \leq D_{cal,lim} = D_{cal,base} + F_{cal,sup}/S = 15.0 \text{ kWh}/(\text{m}^2 \cdot \text{año})$$



donde:

- $D_{cal,edificio}$ : Valor calculado de la demanda energética de calefacción, kWh/(m<sup>2</sup>·año).
- $D_{cal,lim}$ : Valor límite de la demanda energética de calefacción, considerada la superficie útil de los espacios habitables, kWh/(m<sup>2</sup>·año).
- $D_{cal,base}$ : Valor base de la demanda energética de calefacción, para la zona climática de invierno correspondiente al emplazamiento del edificio (tabla 2.1, CTE DB HE 1), 15 kWh/(m<sup>2</sup>·año).
- $F_{cal,sup}$ : Factor corrector por superficie de la demanda energética de calefacción, (tabla 2.1, CTE DB HE 1), 0.
- S: Superficie útil de los espacios habitables del edificio, 986.21 m<sup>2</sup>.

$$D_{ref,edificio} = 11.35 \text{ kWh}/(\text{m}^2 \cdot \text{año}) \leq D_{ref,lim} = 15.0 \text{ kWh}/(\text{m}^2 \cdot \text{año})$$



donde:

- $D_{ref,edificio}$ : Valor calculado de la demanda energética de refrigeración, kWh/(m<sup>2</sup>·año).
- $D_{ref,lim}$ : Valor límite de la demanda energética de refrigeración, kWh/(m<sup>2</sup>·año).

### 1.2.- Resumen del cálculo de la demanda energética.

La siguiente tabla es un resumen de los resultados obtenidos en el cálculo de la demanda energética de calefacción y refrigeración de cada zona habitable, junto a la demanda total del edificio.

Zonas habitables	$S_u$ (m <sup>2</sup> )	$D_{cal}$ (kWh/ /año)	$D_{cal}$ (kWh/ (m <sup>2</sup> ·a))	$D_{cal,base}$ (kWh /(m <sup>2</sup> ·año))	$F_{cal,sup}$	$D_{cal,lim}$ (kWh /(m <sup>2</sup> ·año))	$D_{ref}$ (kWh /año)	$D_{ref}$ (kWh/ (m <sup>2</sup> ·a))	$D_{ref,lim}$ (kWh /(m <sup>2</sup> ·año))
Vivienda 1 (1_izq)	90.20	1559.3	17.3	15	0	15.0	1083.2	12.0	15.0
Vivienda 2 (1_dcha)	90.30	1624.9	18.0	15	0	15.0	1073.4	11.9	15.0
Vivienda 3 (2_izq)	90.20	1169.6	13.0	15	0	15.0	1155.8	12.8	15.0
Vivienda 4 (2_dcha)	90.30	1171.1	13.0	15	0	15.0	1148.4	12.7	15.0
Vivienda 5 (3_izq)	90.20	1172.1	13.0	15	0	15.0	1159.8	12.9	15.0
Vivienda 6 (3_dcha)	90.30	1168.8	12.9	15	0	15.0	1154.4	12.8	15.0
Vivienda 7 (4_izq)	173.41	1696.4	9.8	15	0	15.0	1736.9	10.0	15.0
Vivienda 8 (4_dcha)	173.05	1669.4	9.6	15	0	15.0	1750.8	10.1	15.0
Zona habitable 1	98.25	1584.5	16.1	15	0	15.0	930.8	9.5	15.0
	986.21	12816.2	13.0	15	0	15.0	11193.6	11.4	15.0

donde:

- $S_u$ : Superficie útil de la zona habitable, m<sup>2</sup>.
- $D_{cal}$ : Valor calculado de la demanda energética de calefacción, kWh/(m<sup>2</sup>·año).
- $D_{cal,base}$ : Valor base de la demanda energética de calefacción, para la zona climática de invierno correspondiente al emplazamiento del edificio (tabla 2.1, CTE DB HE 1), 15 kWh/(m<sup>2</sup>·año).
- $F_{cal,sup}$ : Factor corrector por superficie de la demanda energética de calefacción, (tabla 2.1, CTE DB HE 1), 0.
- $D_{cal,lim}$ : Valor límite de la demanda energética de calefacción, considerada la superficie útil de los espacios habitables, kWh/(m<sup>2</sup>·año).
- $D_{ref}$ : Valor calculado de la demanda energética de refrigeración, kWh/(m<sup>2</sup>·año).
- $D_{ref,lim}$ : Valor límite de la demanda energética de refrigeración, kWh/(m<sup>2</sup>·año).

# Justificación del cumplimiento de la exigencia básica HE 1: Limitación de demanda energética

## 1.3.- Resultados mensuales.

### 1.3.1.- Balance energético anual del edificio.

La siguiente gráfica de barras muestra el balance energético del edificio mes a mes, contabilizando la energía perdida o ganada por transmisión térmica al exterior a través de elementos pesados y ligeros ( $Q_{tr,op}$  y  $Q_{tr,w}$ , respectivamente), la energía involucrada en el acoplamiento térmico entre zonas ( $Q_{tr,ac}$ ), la energía intercambiada por ventilación ( $Q_{ve}$ ), la ganancia interna sensible neta ( $Q_{int,s}$ ), la ganancia solar neta ( $Q_{sol}$ ), el calor cedido o almacenado en la masa térmica del edificio ( $Q_{edif}$ ), y el aporte necesario de calefacción ( $Q_H$ ) y refrigeración ( $Q_C$ ).

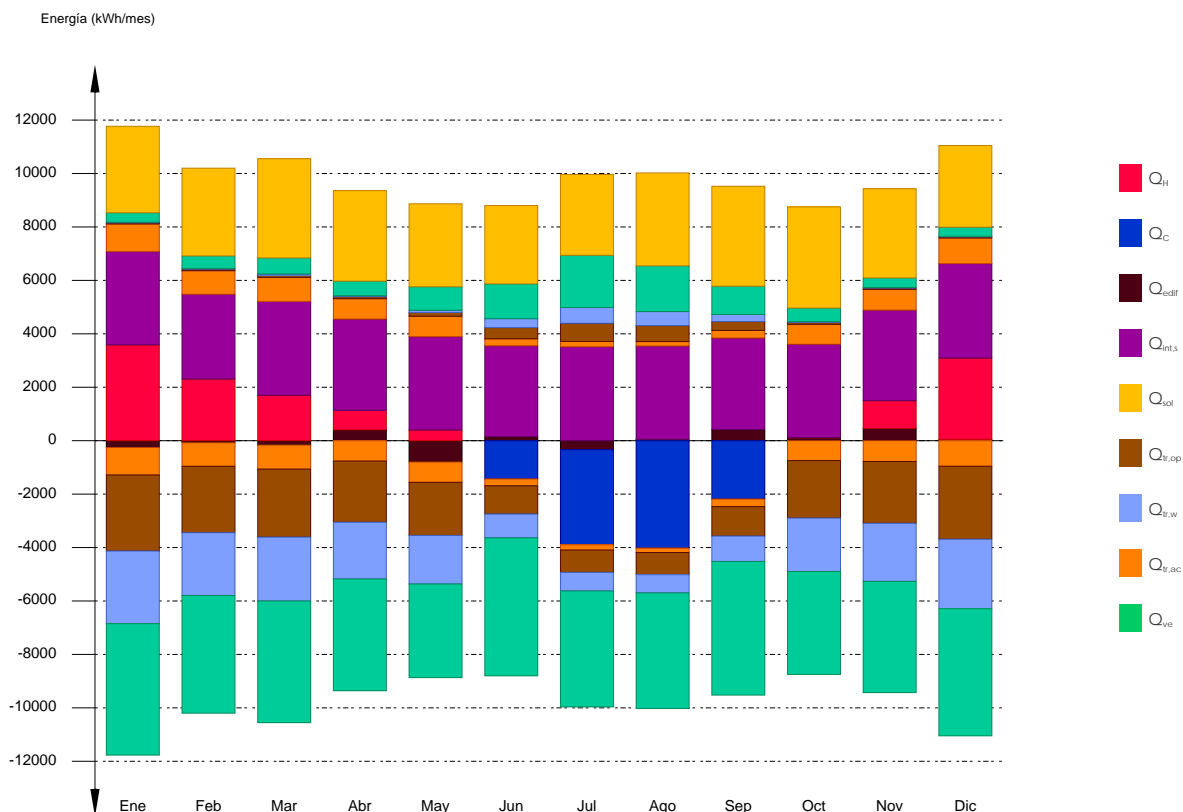

En la siguiente tabla se muestran los valores numéricos correspondientes a la gráfica anterior, del balance energético del edificio completo, como suma de las energías involucradas en el balance energético de cada una de las zonas térmicas que conforman el modelo de cálculo del edificio.

El criterio de signos adoptado consiste en emplear valores positivos para energías aportadas a la zona de cálculo, y negativos para la energía extraída.

	Ene (kWh)	Feb (kWh)	Mar (kWh)	Abr (kWh)	May (kWh)	Jun (kWh)	Jul (kWh)	Ago (kWh)	Sep (kWh)	Oct (kWh)	Nov (kWh)	Dic (kWh)	Año (kWh /año) (kWh/ (m <sup>2</sup> ·a))	
Balance energético anual del edificio.														
$Q_{tr,op}$	43.9	59.2	85.1	73.9	142.9	420.1	680.1	600.7	333.8	68.4	49.2	43.0	-20575.5	-20.9
$Q_{tr,w}$	-2845.8	-2484.1	-2546.4	-2290.7	-1987.2	-1054.7	-835.8	-829.2	-1101.7	-2152.2	-2316.3	-2731.8	-19391.5	-19.7
$Q_{tr,ac}$	1030.9	882.5	900.6	763.9	762.3	259.8	198.6	166.3	282.9	744.9	777.9	958.4		
$Q_{ve}$	-356.5	-468.1	-602.3	-547.0	-880.9	-1306.7	-1954.3	-1712.6	-1057.3	-511.0	-359.9	-341.8	-43070.4	-43.7
	-4920.0	-4405.9	-4553.4	-4182.7	-3504.4	-5162.8	-4338.7	-4323.8	-5002.6	-3853.1	-4162.3	-4759.1		

## Justificación del cumplimiento de la exigencia básica HE 1: Limitación de demanda energética

	Ene	Feb	Mar	Abr	May	Jun	Jul	Ago	Sep	Oct	Nov	Dic	Año	
	(kWh)	(kWh)	(kWh)	(kWh)	(kWh)	(kWh)	(kWh)	(kWh)	(kWh)	(kWh)	(kWh)	(kWh)	(kWh /año)	(kWh/(m <sup>2</sup> ·a))
$Q_{int,s}$	3512.6	3189.0	3533.7	3425.9	3512.6	3425.9	3533.7	3512.6	3447.0	3512.6	3404.7	3554.9	41358.4	41.9
$Q_{sol}$	3265.7	3314.5	3747.2	3419.5	3135.1	2956.1	3054.6	3511.6	3776.7	3820.3	3365.8	3084.6	40056.5	40.6
$Q_{edif}$	-253.8	-76.4	-164.2	404.3	-797.6	145.1	-338.2	48.1	414.5	111.3	457.0	49.9		
$Q_H$	3587.0	2307.3	1697.0	739.1	399.9	--	--	--	--	3.1	1041.0	3041.7	12816.2	13.0
$Q_C$	--	--	--	--	--	-1431.0	-3557.6	-4019.7	-2185.3	--	--	--	-11193.6	-11.4
$Q_{HC}$	3587.0	2307.3	1697.0	739.1	399.9	1431.0	3557.6	4019.7	2185.3	3.1	1041.0	3041.7	24009.8	24.3

donde:

- $Q_{tr,op}$ : Transferencia de calor correspondiente a la transmisión térmica a través de elementos pesados en contacto con el exterior, kWh/(m<sup>2</sup>·año).
- $Q_{tr,w}$ : Transferencia de calor correspondiente a la transmisión térmica a través de elementos ligeros en contacto con el exterior, kWh/(m<sup>2</sup>·año).
- $Q_{tr,ac}$ : Transferencia de calor correspondiente a la transmisión térmica debida al acoplamiento térmico entre zonas, kWh/(m<sup>2</sup>·año).
- $Q_{ve}$ : Transferencia de calor correspondiente a la transmisión térmica por ventilación, kWh/(m<sup>2</sup>·año).
- $Q_{int,s}$ : Transferencia de calor correspondiente a la ganancia de calor interna sensible, kWh/(m<sup>2</sup>·año).
- $Q_{sol}$ : Transferencia de calor correspondiente a la ganancia de calor solar, kWh/(m<sup>2</sup>·año).
- $Q_{edif}$ : Transferencia de calor correspondiente al almacenamiento o cesión de calor por parte de la masa térmica del edificio, kWh/(m<sup>2</sup>·año).
- $Q_H$ : Energía aportada de calefacción, kWh/(m<sup>2</sup>·año).
- $Q_C$ : Energía aportada de refrigeración, kWh/(m<sup>2</sup>·año).
- $Q_{HC}$ : Energía aportada de calefacción y refrigeración, kWh/(m<sup>2</sup>·año).

### 1.3.2.- Demanda energética mensual de calefacción y refrigeración.

Atendiendo únicamente a la demanda energética a cubrir por los sistemas de calefacción y refrigeración, las necesidades energéticas y de potencia útil instantánea a lo largo de la simulación anual se muestran en los siguientes gráficos:

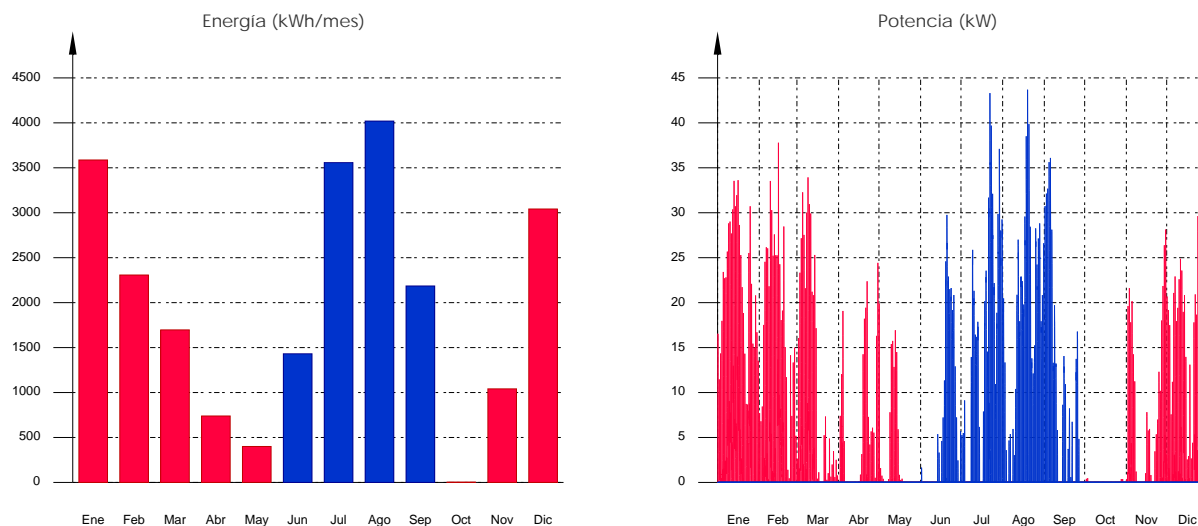

A continuación, en los gráficos siguientes, se muestran las potencias útiles instantáneas por superficie acondicionada de aporte de calefacción y refrigeración para cada uno de los días de la simulación en los que se necesita aporte energético para mantener las condiciones interiores impuestas, mostrando cada uno de esos días de forma superpuesta en una gráfica diaria en horario legal, junto a una curva típica obtenida mediante la ponderación de la energía aportada por día activo, para cada día de cálculo:

# Justificación del cumplimiento de la exigencia básica HE 1: Limitación de demanda energética

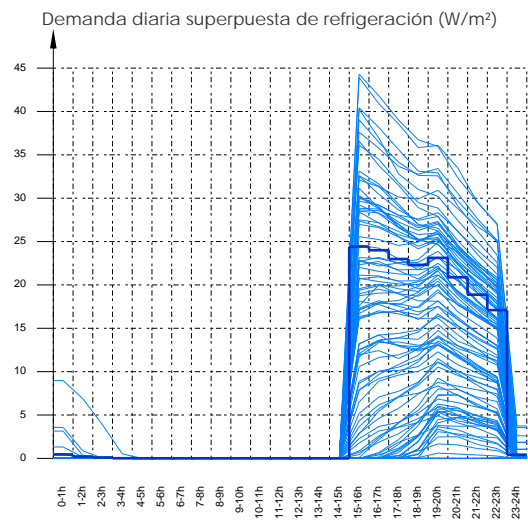
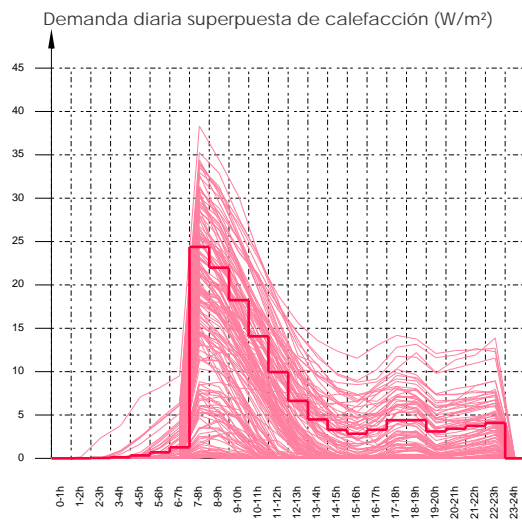

La información gráfica anterior se resume en la siguiente tabla de resultados estadísticos del aporte energético de calefacción y refrigeración:

	Nº activ.	Nº días activos (d)	Nº horas activas (h)	Nº horas por activ. (h)	Potencia típica (W/m²)	Demanda típica por día activo (kWh/m²)
Calefacción	214	178	1797	10	7.23	0.0730
Refrigeración	93	93	727	7	15.61	0.1220

## 1.3.3.- Evolución de la temperatura.

La evolución de la temperatura interior en las zonas modelizadas del edificio objeto de proyecto se muestra en las siguientes gráficas, que muestran la evolución de las temperaturas mínimas, máximas y medias de cada día, junto a la temperatura exterior media diaria, en cada zona:

Vivienda 1 (1\_izq)

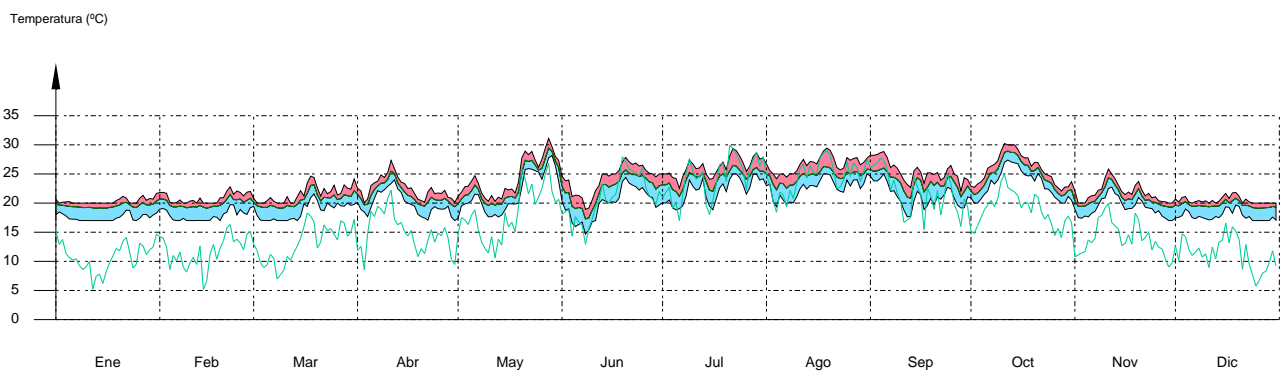

# Justificación del cumplimiento de la exigencia básica HE 1: Limitación de demanda energética

Vivienda 2 (1\_dcha)

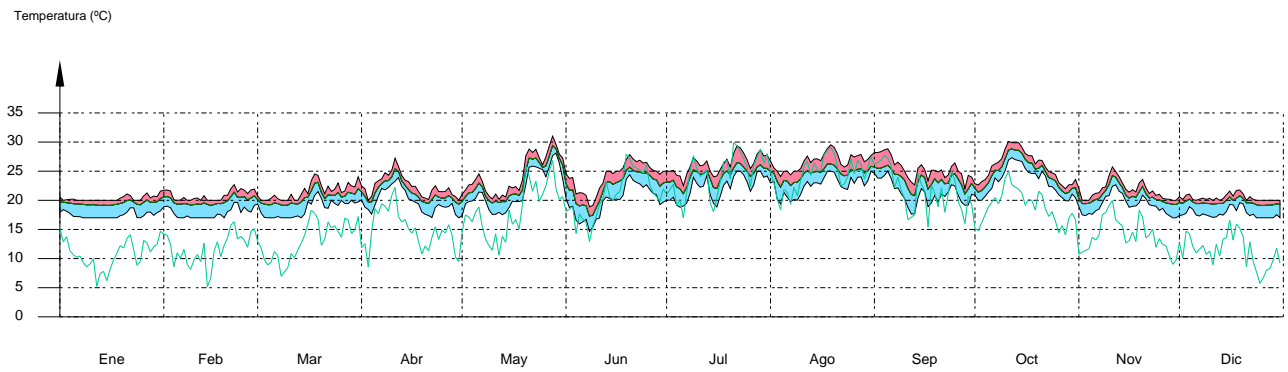

Vivienda 3 (2\_izq)

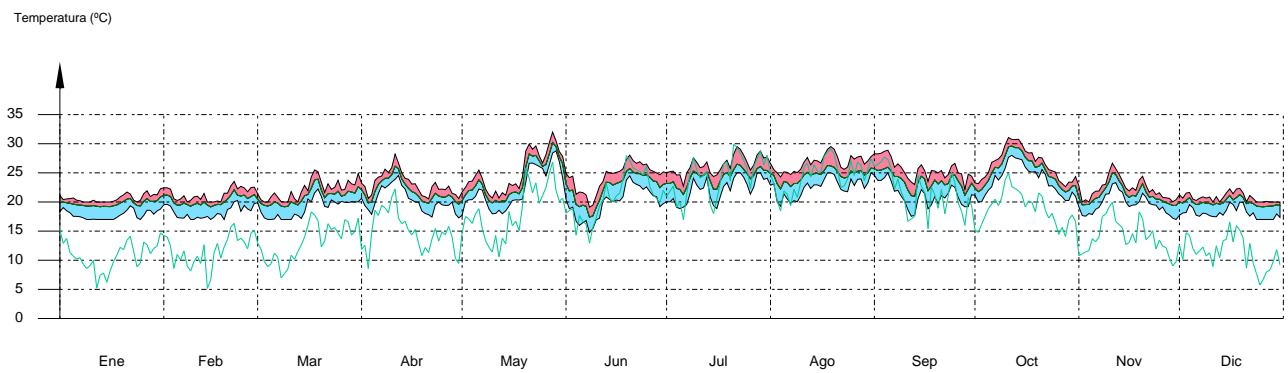

Vivienda 4 (2\_dcha)

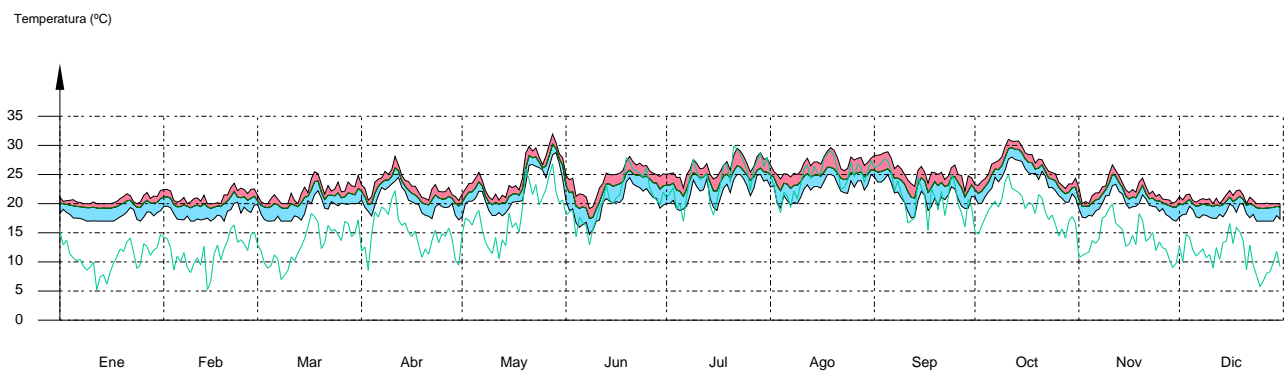

# Justificación del cumplimiento de la exigencia básica HE 1: Limitación de demanda energética

Vivienda 5 (3\_izq)

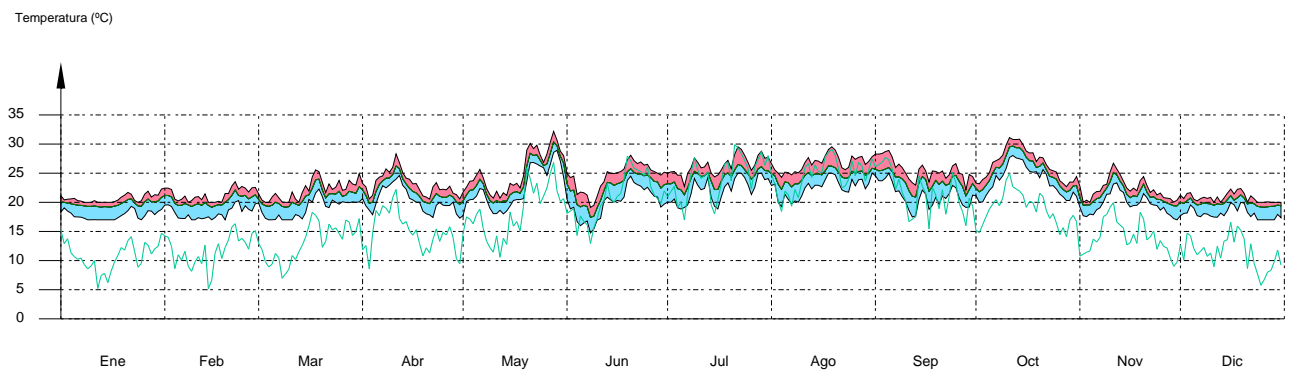

Vivienda 6 (3\_dcha)

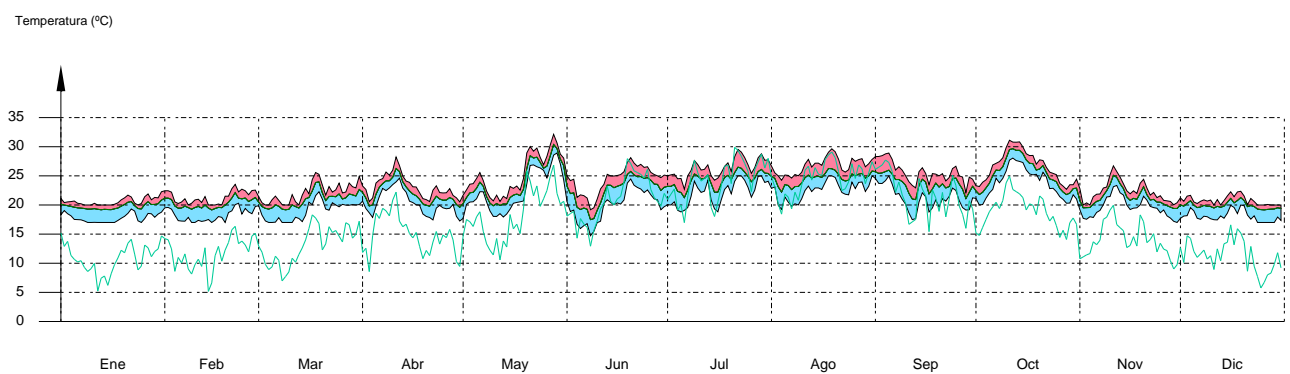

Vivienda 7 (4\_izq)

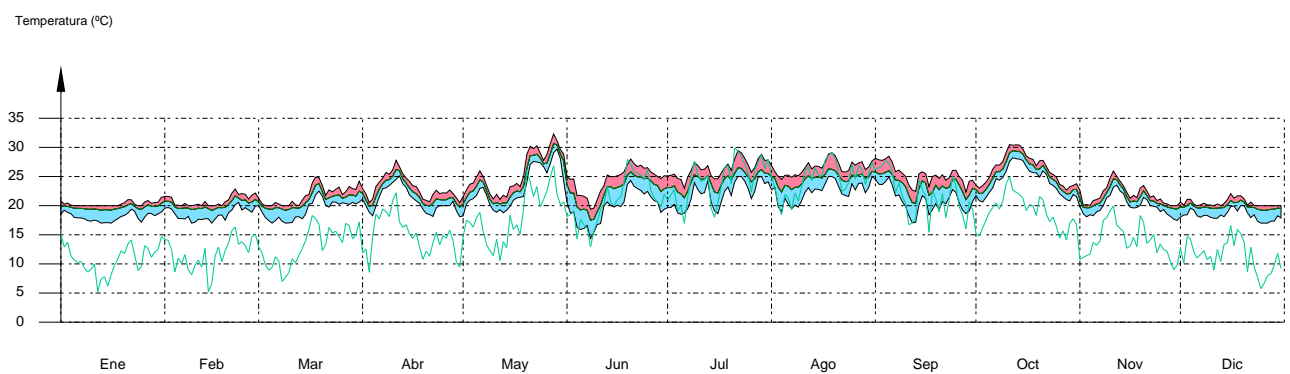

# Justificación del cumplimiento de la exigencia básica HE 1: Limitación de demanda energética

Vivienda 8 (4\_dcha)

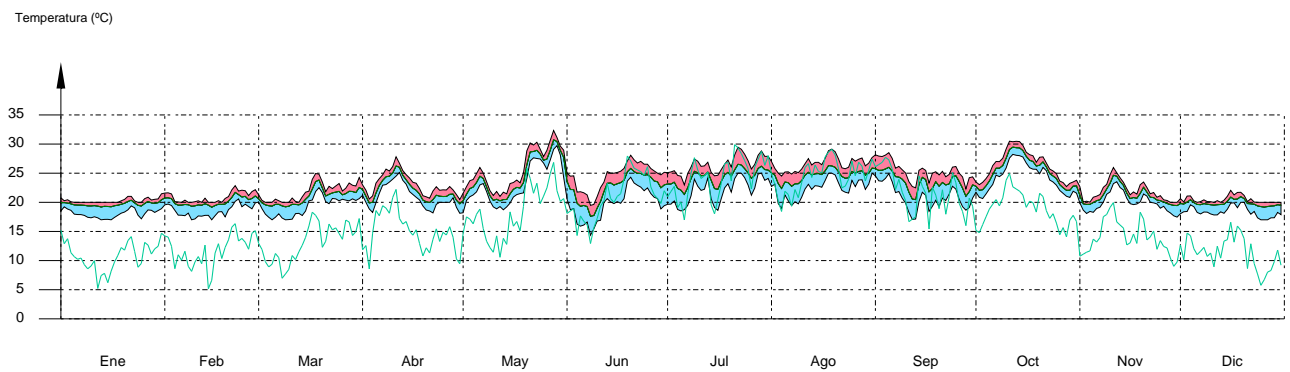

Zona no habitable 1

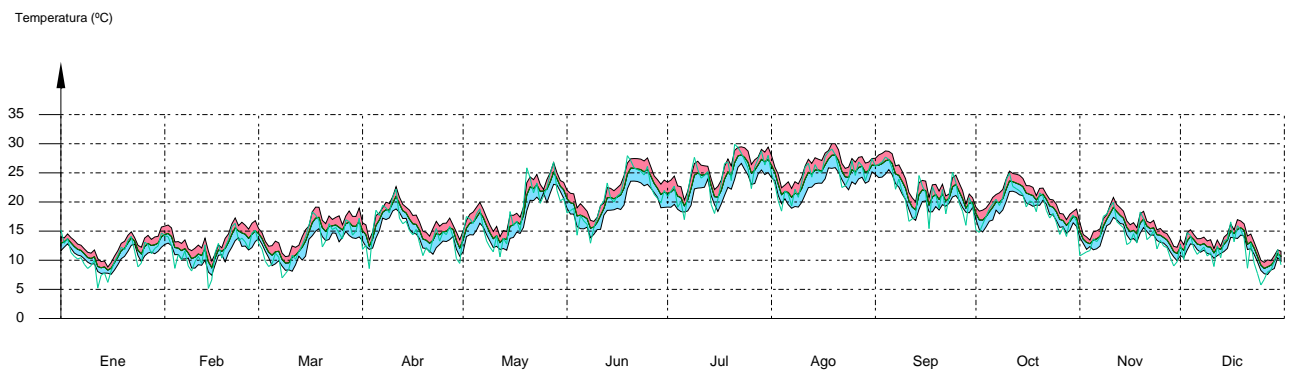

Zona no habitable 2

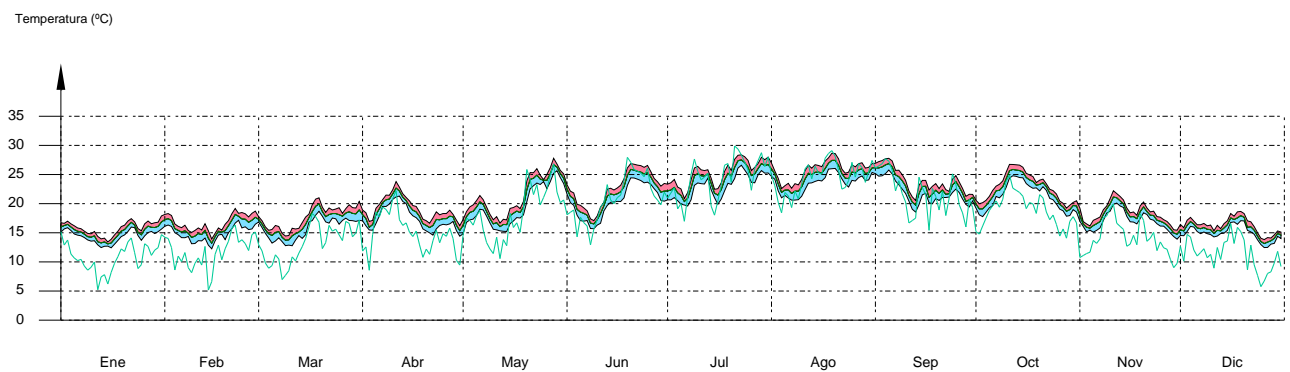



# Justificación del cumplimiento de la exigencia básica HE 1: Limitación de demanda energética

Zona habitable 1

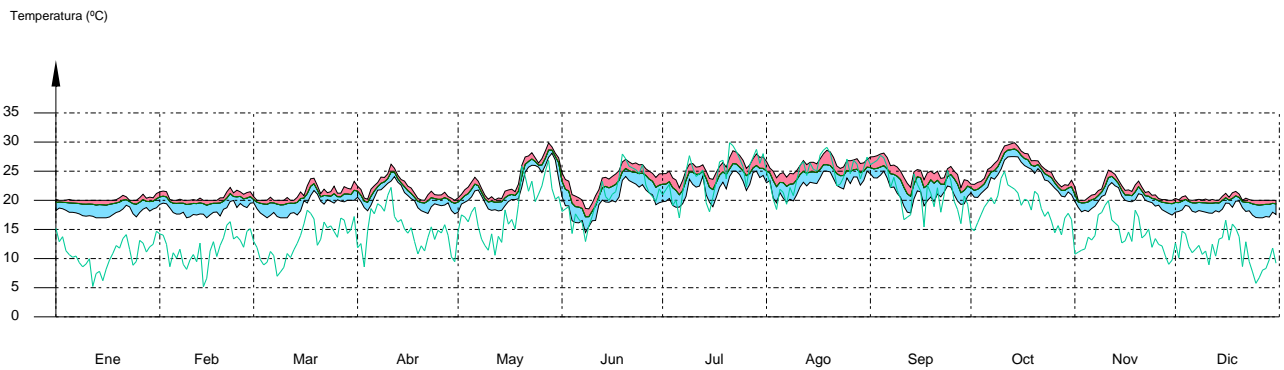

Zona no habitable 3 (Basuras)

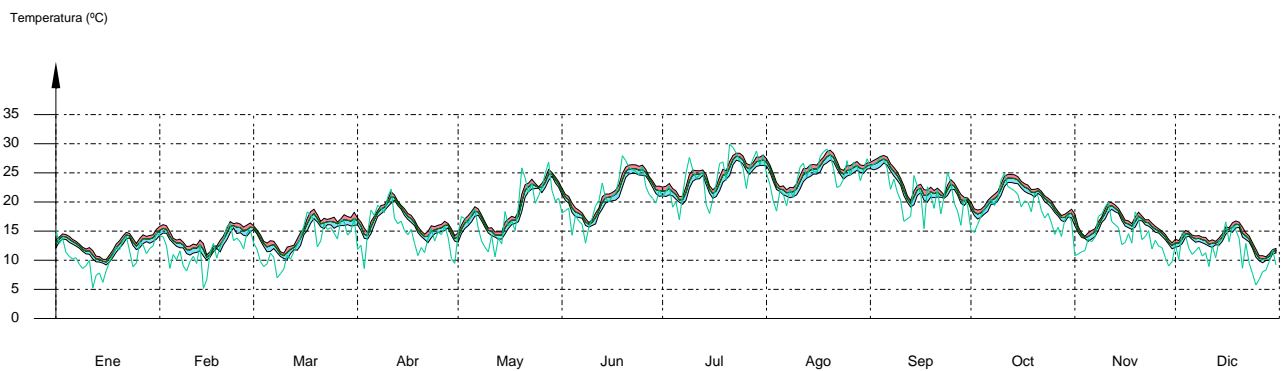

Zona no habitable 4 (Asc\_1)

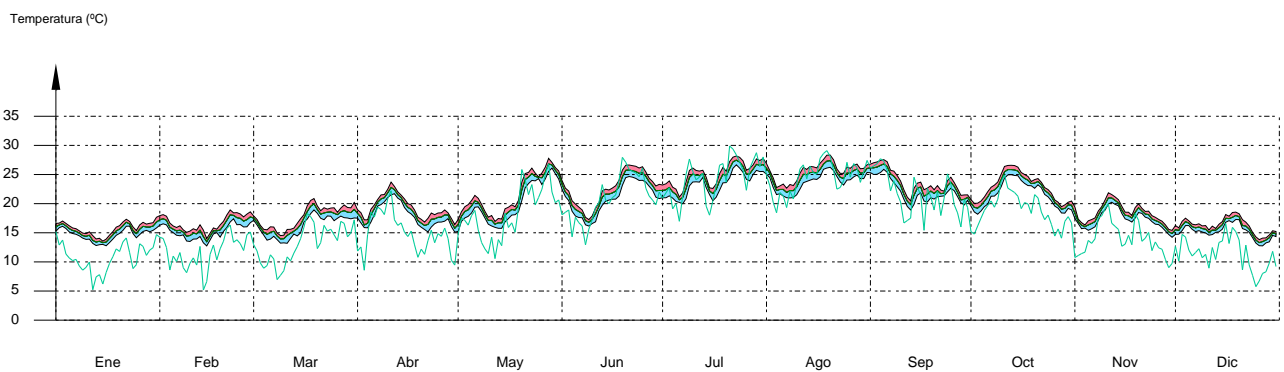

## 1.3.4.- Resultados numéricos del balance energético por zona y mes.

En la siguiente tabla se muestran los resultados de transferencia total de calor por transmisión y ventilación, calor interno total y ganancias solares, y energía necesaria para calefacción y refrigeración, de cada una de las zonas de cálculo del edificio.

El criterio de signos adoptado consiste en emplear valores positivos para energías aportadas a la zona de cálculo, y negativos para la energía extraída.

Las ganancias solares e internas muestran los valores de ganancia energética bruta mensual, junto a la pérdida directa debida al calor que escapa de la zona de cálculo a través de los elementos ligeros, conforme al

# Justificación del cumplimiento de la exigencia básica HE 1: Limitación de demanda energética

método de cálculo utilizado.

Se muestra también el calor neto mensual almacenado o cedido por la masa térmica de cada zona de cálculo, de balance anual nulo.

	Ene (kWh)	Feb (kWh)	Mar (kWh)	Abr (kWh)	May (kWh)	Jun (kWh)	Jul (kWh)	Ago (kWh)	Sep (kWh)	Oct (kWh)	Nov (kWh)	Dic (kWh)	Año (kWh /año) (kWh/ (m <sup>2</sup> ·a))	
Vivienda 1 (1_izq) ( $A_v = 90.20 \text{ m}^2$ ; $V = 208.03 \text{ m}^3$ ; $A_{\text{tot}} = 439.86 \text{ m}^2$ ; $C_m = 18090.052 \text{ kJ/K}$ ; $A_m = 220.33 \text{ m}^2$ )														
$Q_{\text{tr,op}}$	--	0.2	1.2	0.8	5.1	25.2	43.3	37.6	18.5	0.8	0.5	0.1	-1465.4	-16.2
$Q_{\text{tr,w}}$	-206.1	-177.0	-178.2	-155.3	-127.7	-68.8	-53.8	-53.2	-74.7	-145.1	-162.3	-196.5	-1875.4	-20.8
$Q_{\text{tr,ac}}$	14.4	15.0	17.3	17.6	20.9	7.5	9.8	9.2	7.7	22.2	17.6	14.3	-918.7	-10.2
$Q_{\text{ve}}$	-154.1	-129.9	-131.7	-109.2	-103.7	-35.9	-22.2	-17.3	-36.0	-100.8	-109.4	-141.9	-3796.1	-42.1
$Q_{\text{ve}}$	--	0.0	1.2	0.8	6.9	48.1	95.1	85.3	40.2	0.6	0.3	0.0	-3796.1	-42.1
$Q_{\text{ints}}$	321.3	291.7	323.2	313.3	321.3	313.3	323.2	321.3	315.3	321.3	311.4	325.1	3781.9	41.9
$Q_{\text{ints}}$	-1.7	-1.5	-1.7	-1.6	-1.7	-1.6	-1.7	-1.7	-1.6	-1.7	-1.6	-1.7	3781.9	41.9
$Q_{\text{sol}}$	320.5	322.8	363.7	327.5	272.6	262.5	265.9	329.4	367.3	372.8	330.1	302.5	3797.6	42.1
$Q_{\text{sol}}$	-3.3	-3.4	-3.8	-3.4	-2.8	-2.7	-2.8	-3.4	-3.8	-3.9	-3.4	-3.2	3797.6	42.1
$Q_{\text{edif}}$	-10.1	-2.6	-8.8	20.3	-34.0	7.7	-9.7	0.1	14.2	2.8	18.1	2.0		
$Q_{\text{H}}$	417.5	277.1	209.7	102.1	58.5	--	--	--	--	1.3	133.5	359.6	1559.3	17.3
$Q_{\text{C}}$	--	--	--	--	--	-131.7	-336.4	-396.5	-218.6	--	--	--	-1083.2	-12.0
$Q_{\text{HC}}$	417.5	277.1	209.7	102.1	58.5	131.7	336.4	396.5	218.6	1.3	133.5	359.6	2642.5	29.3

Vivienda 2 (1\_dcha) ( $A_v = 90.30 \text{ m}^2$ ;  $V = 208.32 \text{ m}^3$ ;  $A_{\text{tot}} = 441.51 \text{ m}^2$ ;  $C_m = 18248.397 \text{ kJ/K}$ ;  $A_m = 221.79 \text{ m}^2$ )

$Q_{\text{tr,op}}$	--	0.2	1.3	0.8	5.3	25.3	43.3	37.5	18.6	0.9	0.6	0.1	-1452.0	-16.1
$Q_{\text{tr,w}}$	-204.9	-175.7	-176.7	-153.5	-126.1	-68.5	-53.6	-53.1	-74.4	-143.0	-160.8	-195.3	-1859.9	-20.6
$Q_{\text{tr,ac}}$	15.9	16.6	19.2	19.7	23.2	8.3	10.6	9.8	8.2	24.9	19.4	15.7	-1043.4	-11.6
$Q_{\text{ve}}$	-175.8	-147.8	-149.2	-122.7	-115.8	-39.7	-24.3	-19.2	-40.7	-113.6	-124.3	-162.0	-3775.1	-41.8
$Q_{\text{ve}}$	--	0.1	1.3	0.9	7.2	48.2	94.9	85.0	40.2	0.7	0.4	0.1	-3775.1	-41.8
$Q_{\text{ints}}$	321.6	292.0	323.5	313.7	321.6	313.7	323.5	321.6	315.6	321.6	311.7	325.5	3785.8	41.9
$Q_{\text{ints}}$	-1.7	-1.5	-1.7	-1.6	-1.7	-1.6	-1.7	-1.7	-1.6	-1.7	-1.6	-1.7	3785.8	41.9
$Q_{\text{sol}}$	320.5	322.7	363.6	328.1	271.8	262.2	265.2	325.9	367.5	372.8	330.2	302.4	3793.1	42.0
$Q_{\text{sol}}$	-3.3	-3.4	-3.8	-3.4	-2.8	-2.7	-2.8	-3.4	-3.8	-3.9	-3.4	-3.1	3793.1	42.0
$Q_{\text{edif}}$	-9.9	-2.6	-8.8	20.3	-34.3	7.6	-9.8	0.0	14.5	3.0	18.0	2.0		
$Q_{\text{H}}$	433.7	288.5	219.4	105.5	61.7	--	--	--	--	1.8	140.4	374.0	1624.9	18.0
$Q_{\text{C}}$	--	--	--	--	--	-130.2	-334.7	-391.9	-216.6	--	--	--	-1073.4	-11.9
$Q_{\text{HC}}$	433.7	288.5	219.4	105.5	61.7	130.2	334.7	391.9	216.6	1.8	140.4	374.0	2698.4	29.9

Vivienda 3 (2\_izq) ( $A_v = 90.20 \text{ m}^2$ ;  $V = 207.78 \text{ m}^3$ ;  $A_{\text{tot}} = 451.78 \text{ m}^2$ ;  $C_m = 15928.428 \text{ kJ/K}$ ;  $A_m = 234.65 \text{ m}^2$ )

$Q_{\text{tr,op}}$	--	0.0	0.6	0.4	2.8	21.7	38.7	33.9	16.2	0.2	0.2	0.0	-1425.2	-15.8
$Q_{\text{tr,w}}$	-196.5	-170.4	-172.7	-152.3	-127.9	-64.4	-49.1	-47.7	-68.5	-144.9	-157.8	-187.6	-1991.1	-22.1
$Q_{\text{tr,ac}}$	--	--	0.4	0.3	3.0	28.5	54.1	47.8	22.0	0.1	0.1	0.0	-239.8	-2.7
$Q_{\text{ve}}$	-277.9	-240.3	-242.8	-213.4	-179.2	-85.4	-64.7	-62.7	-91.6	-202.8	-221.6	-265.0	-3978.0	-44.1
$Q_{\text{ve}}$	0.2	0.3	0.9	1.6	3.7	2.3	3.4	4.1	3.3	2.1	0.9	0.3	-3978.0	-44.1
$Q_{\text{ve}}$	-26.7	-26.5	-30.7	-30.3	-34.4	-11.6	-6.6	-4.1	-8.2	-31.2	-26.4	-25.8	-3978.0	-44.1
$Q_{\text{ve}}$	--	--	0.5	0.3	4.2	47.2	95.7	86.2	40.3	0.1	0.1	--	-3978.0	-44.1
$Q_{\text{ve}}$	-445.1	-379.9	-384.2	-338.1	-282.4	-380.9	-303.9	-293.7	-364.0	-313.6	-347.4	-419.5	-3978.0	-44.1

## Justificación del cumplimiento de la exigencia básica HE 1: Limitación de demanda energética

	Ene	Feb	Mar	Abr	May	Jun	Jul	Ago	Sep	Oct	Nov	Dic	Año	
	(kWh)	(kWh)	(kWh)	(kWh)	(kWh)	(kWh)	(kWh)	(kWh)	(kWh)	(kWh)	(kWh)	(kWh)	(kWh /año)	(kWh/ (m <sup>2</sup> ·a))
$Q_{int,s}$	321.3	291.7	323.2	313.3	321.3	313.3	323.2	321.3	315.3	321.3	311.4	325.1	3782.4	41.9
$Q_{sol}$	320.8	323.0	363.9	328.9	281.6	274.9	276.8	333.0	368.2	373.0	330.4	302.8	3837.9	42.5
$Q_{edif}$	-10.9	-2.0	-8.2	19.5	-29.9	7.8	-7.5	-0.1	10.4	1.2	17.8	1.9		
$Q_H$	319.7	208.8	154.5	74.7	41.8	--	--	--	--	0.0	97.4	272.6	1169.6	13.0
$Q_C$	--	--	--	--	--	-149.0	-355.6	-413.1	-238.2	--	--	--	-1155.8	-12.8
$Q_{HC}$	319.7	208.8	154.5	74.7	41.8	149.0	355.6	413.1	238.2	0.0	97.4	272.6	2325.4	25.8

Vivienda 4 (2\_dcha) ( $A_v = 90.30 \text{ m}^2$ ;  $V = 207.99 \text{ m}^3$ ;  $A_{ext} = 452.34 \text{ m}^2$ ;  $C_m = 15952.153 \text{ kJ/K}$ ;  $A_m = 235.05 \text{ m}^2$ )

$Q_{tr,op}$	--	0.0	0.6	0.3	2.8	21.5	38.5	33.7	16.1	0.2	0.2	0.0	-1425.5	-15.8
$Q_{tr,w}$	--	--	0.4	0.3	3.0	28.3	53.8	47.6	21.9	0.1	0.1	0.0	-1989.6	-22.0
$Q_{tr,ac}$	0.3	0.4	1.1	2.0	4.2	2.3	3.3	4.1	3.3	2.6	1.1	0.4	-253.5	-2.8
$Q_{ve}$	--	--	0.5	0.3	4.1	46.8	95.1	85.8	40.2	0.1	0.1	--	-3975.0	-44.0
$Q_{int,s}$	321.6	292.0	323.5	313.7	321.6	313.7	323.5	321.6	315.6	321.6	311.7	325.5	3786.3	41.9
$Q_{sol}$	320.8	323.0	363.9	329.9	281.9	274.8	276.1	328.7	368.8	373.1	330.4	302.6	3834.6	42.5
$Q_{edif}$	-10.9	-2.0	-8.2	19.6	-30.2	8.1	-7.4	-0.2	10.5	1.2	17.7	1.9		
$Q_H$	320.8	209.2	155.0	73.3	42.0	--	--	--	--	0.0	97.8	273.1	1171.1	13.0
$Q_C$	--	--	--	--	--	-147.3	-354.3	-408.8	-238.0	--	--	--	-1148.4	-12.7
$Q_{HC}$	320.8	209.2	155.0	73.3	42.0	147.3	354.3	408.8	238.0	0.0	97.8	273.1	2319.5	25.7

Vivienda 5 (3\_izq) ( $A_v = 90.20 \text{ m}^2$ ;  $V = 207.77 \text{ m}^3$ ;  $A_{ext} = 449.79 \text{ m}^2$ ;  $C_m = 15815.919 \text{ kJ/K}$ ;  $A_m = 233.80 \text{ m}^2$ )

$Q_{tr,op}$	--	0.0	0.6	0.3	2.6	22.0	39.3	34.6	16.6	0.2	0.2	0.0	-1461.9	-16.2
$Q_{tr,w}$	--	--	0.4	0.2	2.7	28.3	53.9	47.8	22.0	0.1	0.1	0.0	-1998.8	-22.2
$Q_{tr,ac}$	0.7	0.6	1.3	2.7	8.3	3.9	5.2	4.8	3.7	1.9	1.2	0.6	-170.8	-1.9
$Q_{ve}$	--	--	0.5	0.3	3.6	47.3	96.3	86.8	40.6	0.1	0.1	--	-4000.4	-44.3
$Q_{int,s}$	321.3	291.7	323.2	313.3	321.3	313.3	323.2	321.3	315.3	321.3	311.4	325.1	3782.4	41.9
$Q_{sol}$	320.8	323.1	364.0	328.7	281.5	274.9	277.1	332.2	368.3	373.1	330.4	302.8	3837.1	42.5
$Q_{edif}$	-10.9	-2.1	-8.3	19.5	-30.4	8.4	-7.5	-0.0	10.4	0.9	17.9	1.9		
$Q_H$	322.2	210.1	154.7	73.5	39.8	--	--	--	--	--	97.8	274.1	1172.1	13.0
$Q_C$	--	--	--	--	--	-150.4	-358.5	-413.4	-237.4	--	--	--	-1159.8	-12.9
$Q_{HC}$	322.2	210.1	154.7	73.5	39.8	150.4	358.5	413.4	237.4	--	97.8	274.1	2331.9	25.9

Vivienda 6 (3\_dcha) ( $A_v = 90.30 \text{ m}^2$ ;  $V = 207.98 \text{ m}^3$ ;  $A_{ext} = 450.40 \text{ m}^2$ ;  $C_m = 15839.538 \text{ kJ/K}$ ;  $A_m = 234.23 \text{ m}^2$ )

$Q_{tr,op}$	--	0.0	0.6	0.3	2.5	21.7	39.1	34.3	16.5	0.2	0.2	0.0	-1464.6	-16.2
	-200.7	-174.2	-177.1	-156.7	-133.6	-66.3	-50.2	-48.6	-69.7	-149.5	-161.6	-191.7		

## Justificación del cumplimiento de la exigencia básica HE 1: Limitación de demanda energética

	Ene	Feb	Mar	Abr	May	Jun	Jul	Ago	Sep	Oct	Nov	Dic	Año	
	(kWh)	(kWh)	(kWh)	(kWh)	(kWh)	(kWh)	(kWh)	(kWh)	(kWh)	(kWh)	(kWh)	(kWh)	(kWh /año)	(kWh/ (m <sup>2</sup> ·a))
$Q_{tr,w}$	--	--	0.4	0.2	2.6	28.0	53.6	47.5	21.9	0.1	0.1	0.0	-2000.3	-22.2
$Q_{tr,ac}$	0.6	0.5	1.3	3.0	9.2	4.1	5.6	5.1	3.7	2.0	1.1	0.6	-168.4	-1.9
$Q_{ve}$	--	--	0.5	0.3	3.5	46.7	95.6	86.2	40.5	0.1	0.1	--	-4002.2	-44.3
$Q_{int,s}$	321.6	292.0	323.5	313.7	321.6	313.7	323.5	321.6	315.6	321.6	311.7	325.5	3786.2	41.9
$Q_{sol}$	320.8	323.0	364.0	330.0	282.0	274.8	276.4	328.7	368.8	373.1	330.4	302.6	3834.9	42.5
$Q_{edif}$	-10.9	-2.1	-8.3	19.7	-30.8	8.8	-7.4	-0.2	10.4	0.9	18.0	1.9		
$Q_H$	322.3	209.6	154.4	71.4	39.7	--	--	--	--	--	97.5	273.8	1168.8	12.9
$Q_C$	--	--	--	--	--	-149.1	-357.6	-410.0	-237.7	--	--	--	-1154.4	-12.8
$Q_{HC}$	322.3	209.6	154.4	71.4	39.7	149.1	357.6	410.0	237.7	--	97.5	273.8	2323.3	25.7

Vivienda 7 (4\_izq) ( $A_v = 173.41 \text{ m}^2$ ;  $V = 410.73 \text{ m}^3$ ;  $A_{ext} = 697.16 \text{ m}^2$ ;  $C_m = 36086.802 \text{ kJ/K}$ ;  $A_m = 339.17 \text{ m}^2$ )

$Q_{tr,op}$	0.0	0.8	3.6	2.3	8.2	78.6	136.5	123.7	67.2	2.1	1.8	0.4	-5023.8	-29.0
$Q_{tr,w}$	--	0.2	1.2	0.8	3.3	41.7	78.7	71.5	36.5	0.6	0.6	0.1	-2950.0	-17.0
$Q_{tr,ac}$	11.1	10.8	8.9	4.8	1.0	3.2	3.2	4.2	10.1	7.9	11.5	10.7	-159.5	-0.9
$Q_{ve}$	--	0.1	1.0	0.6	2.7	42.7	88.8	78.6	39.1	0.5	0.5	0.1	-4843.1	-27.9
$Q_{int,s}$	617.6	560.7	621.4	602.4	617.6	602.4	621.4	617.6	606.1	617.6	598.7	625.1	7272.6	41.9
$Q_{sol}$	401.1	427.3	513.7	512.2	546.4	511.5	533.5	547.0	519.8	496.2	415.5	377.4	5744.2	33.1
$Q_{edif}$	-19.1	-7.4	-17.2	38.8	-77.0	27.8	-21.7	0.6	28.6	5.1	38.4	3.3		
$Q_H$	507.4	311.2	218.0	70.8	30.6	--	--	--	--	--	132.5	425.8	1696.4	9.8
$Q_C$	--	--	--	--	--	-234.6	-580.7	-614.1	-307.4	--	--	--	-1736.9	-10.0
$Q_{HC}$	507.4	311.2	218.0	70.8	30.6	234.6	580.7	614.1	307.4	--	132.5	425.8	3433.3	19.8

Vivienda 8 (4\_dcha) ( $A_v = 173.05 \text{ m}^2$ ;  $V = 409.88 \text{ m}^3$ ;  $A_{ext} = 696.87 \text{ m}^2$ ;  $C_m = 36029.790 \text{ kJ/K}$ ;  $A_m = 338.87 \text{ m}^2$ )

$Q_{tr,op}$	0.0	0.7	3.4	2.1	7.6	76.3	133.8	121.6	65.9	1.9	1.7	0.4	-5035.1	-29.1
$Q_{tr,w}$	--	0.1	1.1	0.7	3.1	40.8	77.6	70.7	36.0	0.6	0.5	0.1	-2964.0	-17.1
$Q_{tr,ac}$	11.0	10.5	8.4	4.1	0.6	2.6	2.6	3.8	9.3	7.2	10.9	10.5	-175.1	-1.0
$Q_{ve}$	--	0.1	0.9	0.5	2.6	41.7	87.6	77.9	38.6	0.5	0.4	0.1	-4851.8	-28.0
$Q_{int,s}$	616.3	559.6	620.1	601.1	616.3	601.1	620.1	616.3	604.8	616.3	597.4	623.8	7257.3	41.9
$Q_{sol}$	406.3	433.3	522.0	522.6	560.5	524.2	547.6	556.1	529.7	503.3	420.9	382.0	5850.1	33.8
$Q_{edif}$	-19.2	-7.3	-17.6	39.4	-78.0	28.3	-21.4	0.5	28.4	4.9	38.6	3.2		
$Q_H$	502.9	306.6	214.0	65.7	28.6	--	--	--	--	--	130.2	421.5	1669.4	9.6
$Q_C$	--	--	--	--	--	-237.0	-585.7	-617.4	-310.7	--	--	--	-1750.8	-10.1

# Justificación del cumplimiento de la exigencia básica HE 1: Limitación de demanda energética

	Ene	Feb	Mar	Abr	May	Jun	Jul	Ago	Sep	Oct	Nov	Dic	Año	
	(kWh)	(kWh)	(kWh)	(kWh)	(kWh)	(kWh)	(kWh)	(kWh)	(kWh)	(kWh)	(kWh)	(kWh)	(kWh /año)	(kWh/ (m <sup>2</sup> ·a))
Q <sub>HC</sub>	502.9	306.6	214.0	65.7	28.6	237.0	585.7	617.4	310.7	--	130.2	421.5	3420.2	19.8

Zona no habitable 1 (A<sub>v</sub> = 246.93 m<sup>2</sup>; V = 939.53 m<sup>3</sup>; A<sub>tot</sub> = 1022.03 m<sup>2</sup>; C<sub>m</sub> = 131012.376 kJ/K; A<sub>m</sub> = 894.15 m<sup>2</sup>)

Q <sub>tr,op</sub>	41.3	53.2	66.7	60.5	91.9	94.3	116.9	100.7	74.4	56.8	40.5	39.3	-491.4	-2.0
	-95.7	-106.9	-118.6	-123.2	-100.2	-111.0	-107.2	-115.7	-118.7	-113.5	-113.3	-103.8		
Q <sub>tr,w</sub>	19.7	25.6	32.3	29.4	44.9	46.3	57.6	49.6	36.5	27.6	19.5	18.8	-251.1	-1.0
	-47.8	-53.1	-58.9	-61.3	-49.9	-54.9	-52.9	-57.1	-58.7	-56.5	-56.2	-51.7		
Q <sub>tr,ac</sub>	603.2	507.0	505.5	413.9	381.8	116.1	65.4	52.2	132.7	401.4	437.2	558.2	4107.5	16.6
	--	--	-0.0	-0.0	-0.7	-6.6	-25.7	-24.2	-10.0	--	--	--		
Q <sub>ve</sub>	350.7	455.5	573.8	523.1	798.2	823.8	1023.5	881.2	649.1	490.1	346.7	334.5	-4464.0	-18.1
	-849.8	-943.9	-1047.6	-1089.4	-886.4	-975.1	-939.9	-1014.6	-1043.1	-1004.7	-999.8	-919.8		
Q <sub>sol</sub>	103.6	103.9	106.5	85.4	73.0	55.4	64.7	86.1	103.7	114.9	106.9	99.4	1098.9	4.5
	-0.4	-0.4	-0.4	-0.4	-0.3	-0.2	-0.3	-0.4	-0.4	-0.5	-0.4	-0.4		
Q <sub>edif</sub>	-124.9	-41.0	-59.2	161.8	-352.3	11.9	-202.1	42.2	234.5	84.5	218.9	25.6		

Zona no habitable 2 (A<sub>v</sub> = 14.59 m<sup>2</sup>; V = 45.79 m<sup>3</sup>; A<sub>tot</sub> = 108.16 m<sup>2</sup>; C<sub>m</sub> = 9237.341 kJ/K; A<sub>m</sub> = 85.79 m<sup>2</sup>)

Q <sub>tr,op</sub>	0.0	0.1	0.2	0.2	0.4	0.7	0.9	0.8	0.5	0.2	0.1	0.0	-15.6	-1.1
	-2.2	-2.0	-2.0	-1.9	-1.5	-1.1	-0.9	-1.0	-1.2	-1.8	-1.9	-2.2		
Q <sub>tr,ac</sub>	279.0	234.3	233.8	190.4	181.1	50.9	36.3	30.1	62.8	189.2	202.8	258.2	1078.5	73.9
	-121.7	-101.8	-101.1	-83.1	-77.1	-26.6	-25.2	-21.7	-30.7	-80.9	-88.0	-112.3		
Q <sub>ve</sub>	1.6	5.3	10.2	9.1	21.4	41.7	60.2	52.8	32.6	8.8	5.1	2.6	-1062.9	-72.9
	-150.5	-133.9	-137.4	-124.1	-102.2	-70.6	-60.5	-62.7	-76.6	-118.6	-129.9	-147.4		
Q <sub>edif</sub>	-6.2	-2.0	-3.6	9.4	-22.0	5.0	-10.7	1.6	12.5	3.0	11.9	1.0		

Zona habitable 1 (A<sub>v</sub> = 98.25 m<sup>2</sup>; V = 277.18 m<sup>3</sup>; A<sub>tot</sub> = 432.27 m<sup>2</sup>; C<sub>m</sub> = 29806.807 kJ/K; A<sub>m</sub> = 302.51 m<sup>2</sup>)

Q <sub>tr,op</sub>	--	0.2	1.3	1.1	5.6	23.3	37.5	32.2	16.3	0.8	0.5	0.1	-1204.9	-12.3
	-172.1	-147.1	-146.1	-125.3	-103.1	-54.4	-43.6	-44.3	-62.4	-123.5	-137.7	-164.1		
Q <sub>tr,w</sub>	--	0.2	1.4	1.2	6.3	27.8	46.4	40.4	20.0	0.8	0.5	0.1	-1468.5	-14.9
	-212.4	-180.9	-179.5	-153.9	-126.5	-63.5	-50.8	-51.4	-73.2	-150.8	-168.3	-202.2		
Q <sub>tr,ac</sub>	15.8	20.6	36.9	50.1	73.3	42.4	41.2	31.6	22.5	31.0	18.7	16.4	-2396.7	-24.4
	-408.5	-340.7	-334.3	-267.4	-247.0	-67.2	-42.7	-37.8	-96.3	-276.2	-301.1	-377.8		
Q <sub>ve</sub>	--	0.2	2.2	1.8	9.9	50.0	90.8	80.8	38.9	1.1	0.7	0.1	-3942.9	-40.1
	-405.9	-342.4	-336.7	-285.3	-237.5	-448.0	-374.1	-373.4	-446.1	-274.6	-311.2	-384.3		
Q <sub>int,s</sub>	349.9	317.7	352.0	341.3	349.9	341.3	352.0	349.9	343.4	349.9	339.2	354.2	4123.5	42.0
	-1.5	-1.3	-1.5	-1.4	-1.5	-1.4	-1.5	-1.5	-1.4	-1.5	-1.4	-1.5		
Q <sub>sol</sub>	411.4	393.6	402.8	311.6	272.4	233.1	261.9	329.4	396.0	447.1	420.8	391.9	4235.9	43.1
	-3.5	-3.3	-3.4	-2.6	-2.3	-2.0	-2.2	-2.8	-3.3	-3.8	-3.5	-3.3		
Q <sub>edif</sub>	-13.7	-2.9	-12.4	26.9	-56.9	20.5	-21.0	1.3	26.5	-0.3	28.9	3.3		
Q <sub>H</sub>	440.6	286.2	217.2	102.0	57.2	--	--	--	--	--	113.9	367.2	1584.5	16.1
Q <sub>C</sub>	--	--	--	--	--	-101.9	-293.9	-354.3	-180.7	--	--	--	-930.8	-9.5
Q <sub>HC</sub>	440.6	286.2	217.2	102.0	57.2	101.9	293.9	354.3	180.7	--	113.9	367.2	2515.3	25.6

Zona no habitable 3 (Basuras) (A<sub>v</sub> = 9.18 m<sup>2</sup>; V = 34.90 m<sup>3</sup>; A<sub>tot</sub> = 69.14 m<sup>2</sup>; C<sub>m</sub> = 5917.640 kJ/K; A<sub>m</sub> = 44.84 m<sup>2</sup>)

Q <sub>tr,op</sub>	2.5	3.6	4.8	4.5	7.7	8.4	10.7	8.8	6.1	4.0	2.7	2.4	-82.5	-9.0
	-12.0	-12.6	-13.7	-13.7	-10.8	-11.2	-10.5	-11.7	-12.7	-13.2	-13.7	-12.9		
Q <sub>tr,w</sub>	1.2	1.8	2.4	2.3	3.9	4.3	5.5	4.5	3.1	2.0	1.4	1.2	-42.8	-4.7
	-6.2	-6.5	-7.0	-7.1	-5.6	-5.7	-5.4	-6.0	-6.5	-6.8	-7.0	-6.7		

# Justificación del cumplimiento de la exigencia básica HE 1: Limitación de demanda energética

	Ene	Feb	Mar	Abr	May	Jun	Jul	Ago	Sep	Oct	Nov	Dic	Año	
	(kWh)	(kWh)	(kWh)	(kWh)	(kWh)	(kWh)	(kWh)	(kWh)	(kWh)	(kWh)	(kWh)	(kWh)	(kWh /año)	(kWh/ (m <sup>2</sup> ·a))
$Q_{tr,ac}$	39.5	32.7	32.5	26.3	26.3	8.5	6.5	3.1	6.9	25.0	27.2	36.1	68.0	7.4
$Q_{ve}$	-23.2	-21.2	-20.8	-18.0	-12.2	-8.5	-7.6	-10.9	-14.6	-20.3	-22.0	-23.2	-131.5	-14.3
$Q_{sol}$	3.8	5.5	7.5	7.0	12.1	13.2	16.9	13.8	9.5	6.2	4.2	3.7	188.7	20.6
$Q_{edif}$	-19.1	-20.0	-21.6	-21.7	-17.1	-17.6	-16.5	-18.3	-20.0	-20.8	-21.6	-20.5		
	19.1	18.6	18.7	14.1	10.9	7.4	9.2	14.8	18.5	20.8	19.7	18.2		
	-0.1	-0.1	-0.1	-0.1	-0.1	-0.0	-0.1	-0.1	-0.1	-0.1	-0.1	-0.1		
	-5.4	-1.7	-2.7	6.5	-15.2	1.3	-8.7	1.9	9.9	3.3	9.2	1.7		

Zona no habitable 4 (Asc\_1) ( $A_t = 3.34 \text{ m}^2$ ;  $V = 10.13 \text{ m}^3$ ;  $A_{tot} = 29.19 \text{ m}^2$ ;  $C_m = 2681.005 \text{ kJ/K}$ ;  $A_m = 25.85 \text{ m}^2$ )

$Q_{tr,op}$	0.1	0.2	0.3	0.3	0.6	1.1	1.6	1.4	0.9	0.3	0.2	0.1	-27.8	-8.3
$Q_{tr,ac}$	-3.9	-3.5	-3.6	-3.3	-2.8	-2.0	-1.6	-1.7	-2.0	-3.1	-3.4	-3.8	271.9	81.4
$Q_{ve}$	39.2	33.1	33.5	27.7	28.8	7.8	5.6	4.3	8.7	27.4	28.3	36.4	-247.4	-74.1
$Q_{sol}$	-0.0	-0.0	-0.1	-0.2	-0.2	-1.6	-2.5	-2.5	-1.6	-0.1	-0.1	-0.0	3.3	1.0
$Q_{edif}$	0.4	1.2	2.3	1.9	4.6	9.2	13.8	12.2	7.6	2.0	1.2	0.6		
	-34.2	-30.5	-31.8	-29.5	-24.8	-16.9	-14.1	-14.4	-17.5	-27.5	-29.8	-33.5		
	0.0	0.2	0.4	0.5	0.6	0.5	0.4	0.3	0.3	0.2	0.0	0.0		
	-1.6	-0.7	-1.0	2.5	-6.7	1.9	-3.1	0.5	3.6	0.8	3.5	0.2		

donde:

- $A_t$ : Superficie útil de la zona térmica, m<sup>2</sup>.
- $V$ : Volumen interior neto de la zona térmica, m<sup>3</sup>.
- $A_{tot}$ : Área de todas las superficies que revisten la zona térmica, m<sup>2</sup>.
- $C_m$ : Capacidad calorífica interna de la zona térmica calculada conforme a la Norma ISO 13786:2007 (método detallado), kJ/K.
- $A_m$ : Superficie efectiva de masa de la zona térmica, conforme a la Norma ISO 13790:2011, m<sup>2</sup>.
- $Q_{tr,op}$ : Transferencia de calor correspondiente a la transmisión térmica a través de elementos pesados en contacto con el exterior, kWh/(m<sup>2</sup>·año).
- $Q_{tr,w}$ : Transferencia de calor correspondiente a la transmisión térmica a través de elementos ligeros en contacto con el exterior, kWh/(m<sup>2</sup>·año).
- $Q_{tr,ac}$ : Transferencia de calor correspondiente a la transmisión térmica debida al acoplamiento térmico entre zonas, kWh/(m<sup>2</sup>·año).
- $Q_{ve}$ : Transferencia de calor correspondiente a la transmisión térmica por ventilación, kWh/(m<sup>2</sup>·año).
- $Q_{int,s}$ : Transferencia de calor correspondiente a la ganancia de calor interna sensible, kWh/(m<sup>2</sup>·año).
- $Q_{sol}$ : Transferencia de calor correspondiente a la ganancia de calor solar, kWh/(m<sup>2</sup>·año).
- $Q_{edif}$ : Transferencia de calor correspondiente al almacenamiento o cesión de calor por parte de la masa térmica de la zona, kWh/(m<sup>2</sup>·año).
- $Q_H$ : Energía aportada de calefacción, kWh/(m<sup>2</sup>·año).
- $Q_C$ : Energía aportada de refrigeración, kWh/(m<sup>2</sup>·año).
- $Q_{HC}$ : Energía aportada de calefacción y refrigeración, kWh/(m<sup>2</sup>·año).

## 2.- Modelo de cálculo del edificio.

### 2.1.- Zonificación climática

El edificio objeto del proyecto se sitúa en el municipio de Valencia (provincia de Valencia), con una altura sobre el nivel del mar de 13 m. Le corresponde, conforme al Apéndice B de CTE DB HE 1, la zona climática B3. La pertenencia a dicha zona climática define las solicitudes exteriores para el cálculo de demanda energética, mediante la determinación del clima de referencia asociado, publicado en formato informático (fichero MET) por la Dirección General de Arquitectura, Vivienda y Suelo, del Ministerio de Fomento.

# Justificación del cumplimiento de la exigencia básica HE 1: Limitación de demanda energética

## 2.2.- Zonificación del edificio, perfil de uso y nivel de acondicionamiento.

### 2.2.1.- Agrupaciones de recintos.

Se muestra a continuación la caracterización de los espacios que componen cada una de las zonas de cálculo del edificio. Para cada espacio, se muestran su superficie y volumen, junto a sus condiciones operacionales conforme a los perfiles de uso del Apéndice C de CTE DB HE 1, su acondicionamiento térmico, y sus solicitudes interiores debidas a aportes de energía de ocupantes, equipos e iluminación.

	S (m <sup>2</sup> )	V (m <sup>3</sup> )	b <sub>ve</sub>	ren <sub>h</sub> (1/h)	SQ <sub>ocup,s</sub> (kWh /año)	SQ <sub>equip</sub> (kWh /año)	SQ <sub>lum</sub> (kWh /año)	T <sup>+</sup> calef. media (°C)	T <sup>+</sup> refrig. media (°C)
Vivienda 1 (1_izq) (Zona habitable, Perfil: Residencial)									
D1	16.19	36.34	1.00	0.92	214.4	234.1	234.1	19.0	26.0
D2	9.93	25.26	1.00	0.92	131.4	143.5	143.5	19.0	26.0
D3	8.88	22.59	1.00	0.92	117.5	128.3	128.3	19.0	26.0
P1	4.69	10.53	1.00	0.92	62.1	67.8	67.8	19.0	26.0
S1	27.82	62.42	1.00	0.92	368.2	402.1	402.1	19.0	26.0
B1	3.40	7.62	1.00	0.92	45.0	49.1	49.1	19.0	26.0
B2	3.21	7.21	1.00	0.92	42.5	46.4	46.4	19.0	26.0
C1	16.09	36.08	1.00	0.92	213.0	232.6	232.6	19.0	26.0
	90.20	208.03	1.00	0.92/1.293/4 <sup>++</sup>	1194.1	1303.8	1303.8	19.0	26.0

Vivienda 2 (1_dcha) (Zona habitable, Perfil: Residencial)									
D4	16.16	36.26	1.00	0.92	213.9	233.6	233.6	19.0	26.0
D5	9.02	22.96	1.00	0.92	119.4	130.4	130.4	19.0	26.0
D6	10.06	25.60	1.00	0.92	133.2	145.4	145.4	19.0	26.0
P2	4.69	10.52	1.00	0.92	62.1	67.8	67.8	19.0	26.0
S2	27.72	62.20	1.00	0.92	366.9	400.6	400.6	19.0	26.0
B3	3.38	7.57	1.00	0.92	44.7	48.8	48.8	19.0	26.0
B4	3.19	7.16	1.00	0.92	42.3	46.2	46.2	19.0	26.0
C2	16.07	36.04	1.00	0.92	212.8	232.3	232.3	19.0	26.0
	90.30	208.32	1.00	0.92/1.292/4 <sup>++</sup>	1195.3	1305.1	1305.1	19.0	26.0

Vivienda 3 (2_izq) (Zona habitable, Perfil: Residencial)									
D1	16.19	37.31	1.00	0.92	214.4	234.1	234.1	19.0	26.0
D2	9.93	22.87	1.00	0.92	131.4	143.5	143.5	19.0	26.0
D3	8.88	20.45	1.00	0.92	117.5	128.3	128.3	19.0	26.0
P1	4.69	10.81	1.00	0.92	62.1	67.8	67.8	19.0	26.0
S1	27.82	64.08	1.00	0.92	368.2	402.1	402.1	19.0	26.0
B1	3.40	7.82	1.00	0.92	45.0	49.1	49.1	19.0	26.0
B2	3.21	7.40	1.00	0.92	42.5	46.4	46.4	19.0	26.0
C1	16.09	37.04	1.00	0.92	213.0	232.6	232.6	19.0	26.0
	90.20	207.78	1.00	0.92/1.300/4 <sup>++</sup>	1194.1	1303.8	1303.8	19.0	26.0

Vivienda 4 (2_dcha) (Zona habitable, Perfil: Residencial)									
D4	16.16	37.23	1.00	0.92	213.9	233.6	233.6	19.0	26.0
D5	9.02	20.78	1.00	0.92	119.4	130.4	130.4	19.0	26.0
D6	10.06	23.18	1.00	0.92	133.2	145.4	145.4	19.0	26.0
P2	4.69	10.81	1.00	0.92	62.1	67.8	67.8	19.0	26.0
S2	27.72	63.86	1.00	0.92	366.9	400.6	400.6	19.0	26.0
B3	3.38	7.78	1.00	0.92	44.7	48.8	48.8	19.0	26.0
B4	3.19	7.35	1.00	0.92	42.3	46.2	46.2	19.0	26.0
C2	16.07	37.00	1.00	0.92	212.8	232.3	232.3	19.0	26.0

## Justificación del cumplimiento de la exigencia básica HE 1: Limitación de demanda energética

S (m <sup>2</sup> )	V (m <sup>3</sup> )	b <sub>ve</sub>	ren <sub>h</sub> (1/h)	SQ <sub>ocup,s</sub> (kWh /año)	SQ <sub>equip</sub> (kWh /año)	SQ <sub>lum</sub> (kWh /año)	T <sup>o</sup> calef. media (°C)	T <sup>o</sup> refrig. media (°C)
90.30	207.99	1.00	0.92/1.299/4 <sup>++</sup>	1195.3	1305.1	1305.1	19.0	26.0

### Vivienda 5 (3\_izq) (Zona habitable, Perfil: Residencial)

D1	16.19	37.30	1.00	0.92	214.4	234.1	234.1	19.0	26.0
D2	9.93	22.87	1.00	0.92	131.4	143.5	143.5	19.0	26.0
D3	8.88	20.45	1.00	0.92	117.5	128.3	128.3	19.0	26.0
P1	4.69	10.81	1.00	0.92	62.1	67.8	67.8	19.0	26.0
S1	27.82	64.08	1.00	0.92	368.2	402.1	402.1	19.0	26.0
B1	3.40	7.82	1.00	0.92	45.0	49.1	49.1	19.0	26.0
B2	3.21	7.40	1.00	0.92	42.5	46.4	46.4	19.0	26.0
C1	16.09	37.04	1.00	0.92	213.0	232.6	232.6	19.0	26.0
	90.20	207.77	1.00	0.92/1.304/4 <sup>++</sup>	1194.1	1303.8	1303.8	19.0	26.0

### Vivienda 6 (3\_dcha) (Zona habitable, Perfil: Residencial)

D4	16.16	37.22	1.00	0.92	213.9	233.6	233.6	19.0	26.0
D5	9.02	20.78	1.00	0.92	119.4	130.4	130.4	19.0	26.0
D6	10.06	23.18	1.00	0.92	133.2	145.4	145.4	19.0	26.0
P2	4.69	10.81	1.00	0.92	62.1	67.8	67.8	19.0	26.0
S2	27.72	63.86	1.00	0.92	366.9	400.6	400.6	19.0	26.0
B3	3.38	7.78	1.00	0.92	44.7	48.8	48.8	19.0	26.0
B4	3.19	7.35	1.00	0.92	42.3	46.2	46.2	19.0	26.0
C2	16.07	37.00	1.00	0.92	212.8	232.3	232.3	19.0	26.0
	90.30	207.98	1.00	0.92/1.303/4 <sup>++</sup>	1195.3	1305.1	1305.1	19.0	26.0

### Vivienda 7 (4\_izq) (Zona habitable, Perfil: Residencial)

D1	16.72	37.52	1.00	0.40	221.4	241.7	241.7	19.0	26.0
D2	8.39	19.33	1.00	0.40	111.0	121.2	121.2	19.0	26.0
P1	15.01	36.64	1.00	0.40	198.7	216.9	216.9	19.0	26.0
S1	32.80	76.54	1.00	0.40	434.2	474.1	474.1	19.0	26.0
B1	4.17	9.59	1.00	0.40	55.2	60.3	60.3	19.0	26.0
B2	4.34	10.00	1.00	0.40	57.5	62.8	62.8	19.0	26.0
C1	14.88	34.25	1.00	0.40	197.0	215.0	215.0	19.0	26.0
S1	77.10	186.85	1.00	0.40	1020.7	1114.4	1114.4	19.0	26.0
	173.41	410.73	1.00	0.40/0.841/4 <sup>++</sup>	2295.6	2506.5	2506.5	19.0	26.0

### Vivienda 8 (4\_dcha) (Zona habitable, Perfil: Residencial)

C2	14.87	34.22	1.00	0.40	196.8	214.9	214.9	19.0	26.0
D3	8.66	19.95	1.00	0.40	114.6	125.1	125.1	19.0	26.0
D4	16.50	37.02	1.00	0.40	218.4	238.5	238.5	19.0	26.0
B3	4.34	10.00	1.00	0.40	57.5	62.8	62.8	19.0	26.0
B4	4.14	9.53	1.00	0.40	54.8	59.8	59.8	19.0	26.0
P2	14.97	36.51	1.00	0.40	198.2	216.4	216.4	19.0	26.0
S2	32.69	76.32	1.00	0.40	432.8	472.6	472.6	19.0	26.0
S2	76.88	186.32	1.00	0.40	1017.7	1111.2	1111.2	19.0	26.0
	173.05	409.88	1.00	0.40/0.841/4 <sup>++</sup>	2290.8	2501.2	2501.2	19.0	26.0

### Zona no habitable 1 (Zona no habitable)



## Justificación del cumplimiento de la exigencia básica HE 1: Limitación de demanda energética

	S (m <sup>2</sup> )	V (m <sup>3</sup> )	b <sub>ve</sub>	ren <sub>h</sub> (1/h)	SQ <sub>ocup,s</sub> (kWh /año)	SQ <sub>equip</sub> (kWh /año)	SQ <sub>lum</sub> (kWh /año)	T <sub>calef.</sub> media (°C)	T <sub>refrig.</sub> media (°C)
Garaje	214.57	816.03	1.00	3.00	--	--	--		
T1	3.63	13.84	1.00	1.00	--	--	--		
T2	3.66	13.98	1.00	1.00	--	--	--		
T3	3.65	13.93	1.00	1.00	--	--	--		
T4	3.65	13.94	1.00	1.00	--	--	--		
T5	3.66	13.98	1.00	1.00	--	--	--		Oscilación libre
T6	3.65	13.94	1.00	1.00	--	--	--		
T7	4.19	16.01	1.00	1.00	--	--	--		
T8	4.11	15.69	1.00	1.00	--	--	--		
VI	2.15	8.19	1.00	1.00	--	--	--		
	246.93	939.53	1.00	2.74	0.0	0.0	0.0		

### Zona no habitable 2 (Zona no habitable)

Asc_0	3.06	12.10	1.00	3.00	--	--	--		
Asc_1	2.88	8.64	1.00	3.00	--	--	--		
Asc_1	2.88	8.64	1.00	3.00	--	--	--		Oscilación libre
Asc_1	2.88	8.62	1.00	3.00	--	--	--		
Asc_1	2.88	7.78	1.00	3.00	--	--	--		
	14.59	45.79	1.00	3.00	0.0	0.0	0.0		

### Zona habitable 1 (Zona habitable, Perfil: Residencial)

Zaguán	25.25	91.42	1.00	0.63	334.3	365.0	365.0	19.0	26.0
Esc_1	14.64	38.21	1.00	0.63	193.8	211.6	211.6	19.0	26.0
Esc_1	14.64	38.66	1.00	0.63	193.8	211.6	211.6	19.0	26.0
Esc_1	14.64	38.66	1.00	0.63	193.8	211.6	211.6	19.0	26.0
Esc_1	14.65	38.79	1.00	0.63	193.9	211.7	211.7	19.0	26.0
Esc_1	14.44	31.44	1.00	0.63	191.1	208.7	208.7	19.0	26.0
	98.25	277.18	1.00	0.63/1.032/4**	1300.7	1420.1	1420.1	19.0	26.0

### Zona no habitable 3 (Basuras) (Zona no habitable)

Basuras	9.18	34.90	1.00	1.00	--	--	--		Oscilación libre
	9.18	34.90	1.00	1.00	0.0	0.0	0.0		

### Zona no habitable 4 (Asc\_1) (Zona no habitable)

Asc_1	3.34	10.13	1.00	3.00	--	--	--		Oscilación libre
	3.34	10.13	1.00	3.00	0.0	0.0	0.0		

donde:

- S: Superficie útil interior del recinto, m<sup>2</sup>.
- V: Volumen interior neto del recinto, m<sup>3</sup>.
- b<sub>ve</sub>: Factor de ajuste de la temperatura de suministro de ventilación. En caso de disponer de una unidad de recuperación de calor, el factor de ajuste de la temperatura de suministro de ventilación para el caudal de aire procedente de la unidad de recuperación es igual a  $b_{ve} = (1 - f_{ve,frac} \cdot h_{ru})$ , donde  $h_{ru}$  es el rendimiento de la unidad de recuperación y  $f_{ve,frac}$  es la fracción del caudal de aire total que circula a través del recuperador.
- ren<sub>h</sub>: Número de renovaciones por hora del aire del recinto.
- \*: Valor medio del número de renovaciones hora del aire de la zona habitable, incluyendo las infiltraciones calculadas y los periodos de 'free cooling'.
- \*\* : Valor nominal del número de renovaciones hora del aire de la zona habitable en régimen de 'free cooling' (ventilación natural nocturna en las noches de verano).
- Q<sub>ocup,s</sub>: Sumatorio de la carga interna sensible debida a la ocupación del recinto a lo largo del año, conforme al perfil anual asignado y a su superficie, kWh/año.
- Q<sub>equip</sub>: Sumatorio de la carga interna debida a los equipos presentes en el recinto a lo largo del año, conforme al perfil anual asignado y a su superficie, kWh/año.

# Justificación del cumplimiento de la exigencia básica HE 1: Limitación de demanda energética

$Q_{lum}$ : Sumatorio de la carga interna debida a la iluminación del recinto a lo largo del año, conforme al perfil anual asignado y a su superficie, kWh/año.

$T^{\circ}$  calef. media: Valor medio en los intervalos de operación de la temperatura de consigna de calefacción, °C.

$T^{\circ}$  refriger. media: Valor medio en los intervalos de operación de la temperatura de consigna de refrigeración, °C.

## 2.2.2.- Perfiles de uso utilizados.

Los perfiles de uso utilizados en el cálculo del edificio, obtenidos del Apéndice C de CTE DB HE 1, son los siguientes:

		Distribución horaria																								
		1h	2h	3h	4h	5h	6h	7h	8h	9h	10h	11h	12h	13h	14h	15h	16h	17h	18h	19h	20h	21h	22h	23h	24h	
Perfil: Residencial (uso residencial)																										
Temp. Consigna Alta (°C)																										
Enero a Mayo		-	-	-	-	-	-	-	-	-	-	-	-	-	-	-	-	-	-	-	-	-	-	-	-	-
Junio a Septiembre		27	27	27	27	27	27	27	-	-	-	-	-	-	-	25	25	25	25	25	25	25	25	25	25	27
Octubre a Diciembre		-	-	-	-	-	-	-	-	-	-	-	-	-	-	-	-	-	-	-	-	-	-	-	-	-
Temp. Consigna Baja (°C)																										
Enero a Mayo		17	17	17	17	17	17	17	20	20	20	20	20	20	20	20	20	20	20	20	20	20	20	20	20	17
Junio a Septiembre		-	-	-	-	-	-	-	-	-	-	-	-	-	-	-	-	-	-	-	-	-	-	-	-	-
Octubre a Diciembre		17	17	17	17	17	17	17	20	20	20	20	20	20	20	20	20	20	20	20	20	20	20	20	20	17
Ocupación sensible (W/m²)																										
Laboral		2.15	2.15	2.15	2.15	2.15	2.15	2.15	0.54	0.54	0.54	0.54	0.54	0.54	0.54	1.08	1.08	1.08	1.08	1.08	1.08	1.08	1.08	1.08	1.08	2.15
Sábado y Festivo		2.15	2.15	2.15	2.15	2.15	2.15	2.15	2.15	2.15	2.15	2.15	2.15	2.15	2.15	2.15	2.15	2.15	2.15	2.15	2.15	2.15	2.15	2.15	2.15	2.15
Ocupación latente (W/m²)																										
Laboral		1.36	1.36	1.36	1.36	1.36	1.36	1.36	0.34	0.34	0.34	0.34	0.34	0.34	0.34	0.68	0.68	0.68	0.68	0.68	0.68	0.68	0.68	0.68	0.68	1.36
Sábado y Festivo		1.36	1.36	1.36	1.36	1.36	1.36	1.36	1.36	1.36	1.36	1.36	1.36	1.36	1.36	1.36	1.36	1.36	1.36	1.36	1.36	1.36	1.36	1.36	1.36	1.36
Iluminación (W/m²)																										
Laboral, Sábado y Festivo		2.2	2.2	2.2	2.2	2.2	2.2	2.2	1.32	1.32	1.32	1.32	1.32	1.32	1.32	1.32	1.32	1.32	1.32	1.32	2.20	4.40	4.40	4.40	4.40	2.2
Equipos (W/m²)																										
Laboral, Sábado y Festivo		2.2	2.2	2.2	2.2	2.2	2.2	2.2	1.32	1.32	1.32	1.32	1.32	1.32	1.32	1.32	1.32	1.32	1.32	2.20	4.40	4.40	4.40	4.40	2.2	
Ventilación verano																										
Laboral, Sábado y Festivo		4.0	4.0	4.0	4.0	4.0	4.0	4.0	4.0	*	*	*	*	*	*	*	*	*	*	*	*	*	*	*	*	*
Ventilación invierno																										
Laboral, Sábado y Festivo		*	*	*	*	*	*	*	*	*	*	*	*	*	*	*	*	*	*	*	*	*	*	*	*	*

donde:

\*: Número de renovaciones correspondiente al mínimo exigido por CTE DB HS 3.

## 2.3.- Descripción geométrica y constructiva del modelo de cálculo.

### 2.3.1.- Composición constructiva. Elementos constructivos pesados.

La transmisión de calor al exterior a través de los elementos constructivos pesados que forman la envolvente térmica de las zonas habitables del edificio (-8.8 kWh/(m²·año)) supone el 22.2% de la transmisión térmica total a través de dicha envolvente (-39.6 kWh/(m²·año)).

	Tipo	S (m²)	c (kJ/(m²·K))	U (W/(m²·K))	$\dot{a}Q_{tr}$ (kWh/año)	a	I. (°)	O. (°)	$F_{sh.o}$	$\dot{a}Q_{sol}$ (kWh/año)
Vivienda 1 (1_izq)										
Fachada ventilada con placas de piedra natural		3.93	14.72	0.25	-44.2	0.6	V	S(180)	0.87	20.8









# Justificación del cumplimiento de la exigencia básica HE 1: Limitación de demanda energética

	Tipo	S (m <sup>2</sup> )	c (kJ/ (m <sup>2</sup> ·K))	U (W/ (m <sup>2</sup> ·K))	âQ <sub>e</sub> (kWh /año)	a	I. (°)	O. (°)	F <sub>sh,o</sub>	âQ <sub>cal</sub> (kWh /año)
Medianería de dos hojas de fábrica		31.06	90.13							
Fachada ventilada con placas de piedra natural		1.24	14.72	0.25	-13.9	0.6	V	S(180)	0.96	7.2
Tabique PYL 78/600(48) LM		83.47	12.88							
Tabique PYL 78/600(48) LM		30.13	22.48							
Tabique de una hoja, con trasdosado en una cara		0.84	18.25	0.03	-1.3					
Forjado unidireccional		34.82	72.61	0.34	-454.2					Hacia 'Zona no habitable 1'
Forjado unidireccional		9.04	72.61	0.34	-101.3					Hacia 'Zona no habitable 3 (Basuras)'
Forjado unidireccional		9.70	73.01	0.34	-128.3					Hacia 'Zona no habitable 1'
Forjado unidireccional		48.70	16.89	0.38	58.6					Desde 'Vivienda 3 (2_izq)'
Fachada ventilada con placas de piedra natural		4.84	14.72	0.25	-54.3	0.6	V	N(0)	0.86	5.4
Forjado unidireccional		18.80	146.93	0.80	47.3					Desde 'Vivienda 3 (2_izq)'
Fachada ventilada con placas de piedra natural		4.21	14.72	0.25	-47.3	0.6	V	N(0)	0.85	4.6
Fachada ventilada con placas de piedra natural		4.04	14.72	0.25	-45.5	0.6	V	S(180)	0.82	20.1
Tabique de una hoja, con trasdosado en una cara		16.63	34.81	0.48	-4.8					Hacia 'Zona habitable 1'
Tabique de una hoja, con trasdosado en una cara		2.38	18.25	0.49	-21.9					Hacia 'Zona no habitable 2'
Forjado unidireccional		9.18	71.43	0.23	0.6					Desde 'Zona habitable 1'
Losa maciza		0.56	73.52	0.37	-9.6	0.6	H		0.12	0.8
Tabique PYL 78/600(48) LM		30.13	12.94							
Tabique de una hoja, con trasdosado en una cara		7.93	18.33	0.03	-12.5					
Forjado unidireccional		21.91	134.91	0.35	-298.5					Hacia 'Zona no habitable 1'
Forjado unidireccional		22.70	17.09	0.40	28.8					Desde 'Vivienda 3 (2_izq)'
Fachada ventilada con placas de piedra natural		4.04	14.72	0.25	-45.4	0.6	V	N(0)	0.92	4.8
Fachada ventilada con placas de piedra natural		3.85	14.72	0.25	-43.2	0.6	V	O(-90)	0.31	5.2
Tabique de una hoja, con trasdosado en una cara		4.50	18.33	0.49	-41.5					Hacia 'Zona no habitable 2'
Tabique de una hoja con trasdosado en ambas caras		14.84	25.53	0.28	-1.6					Hacia 'Vivienda 2 (1_dcha)'
					-317.1	-916.8*				68.7























## Vivienda 2 (1\_dcha)

Fachada ventilada con placas de piedra natural		1.24	14.72	0.25	-13.8	0.6	V	S(180)	0.96	7.2
Medianería de dos hojas de fábrica		31.23	90.13							
Fachada ventilada con placas de piedra natural		3.90	14.72	0.25	-43.4	0.6	V	S(180)	0.87	20.6
Tabique PYL 78/600(48) LM		30.16	22.48							
Tabique de una hoja, con trasdosado en una cara		0.84	18.25	0.03	-1.3					
Tabique PYL 78/600(48) LM		83.80	12.88							
Forjado unidireccional		49.98	72.61	0.34	-644.8					Hacia 'Zona no habitable 1'
Forjado unidireccional		14.57	73.01	0.34	-190.7					Hacia 'Zona no habitable 1'
Forjado unidireccional		48.57	16.89	0.38	65.5					Desde 'Vivienda 4 (2_dcha)'
Fachada ventilada con placas de piedra natural		4.20	14.72	0.25	-46.8	0.6	V	N(0)	0.85	4.5
Forjado unidireccional		19.08	146.93	0.80	53.9					Desde 'Vivienda 4 (2_dcha)'
Fachada ventilada con placas de piedra natural		4.82	14.72	0.25	-53.6	0.6	V	N(0)	0.86	5.3
Fachada ventilada con placas de piedra natural		4.07	14.72	0.25	-45.3	0.6	V	S(180)	0.82	20.2
Tabique de una hoja, con trasdosado en una cara		16.63	34.81	0.48	-1.8					Hacia 'Zona habitable 1'
Tabique de una hoja, con trasdosado en una cara		2.38	18.25	0.49	-21.5					Hacia 'Zona no habitable 2'
Tabique de una hoja, con trasdosado en una cara		7.88	18.33	0.03	-12.3					









# Justificación del cumplimiento de la exigencia básica HE 1: Limitación de demanda energética

	Tipo	S (m <sup>2</sup> )	c (kJ/ (m <sup>2</sup> ·K))	U (W/ (m <sup>2</sup> ·K))	âQ <sub>e</sub> (kWh /año)	a	I. (°)	O. (°)	F <sub>sho</sub>	âQ <sub>cal</sub> (kWh /año)
Tabique PYL 78/600(48) LM		30.16	12.94							
Forjado unidireccional		5.82	135.44	0.36	-79.5					Hacia 'Zona no habitable 1'
Forjado unidireccional		22.65	17.09	0.40	32.2					Desde 'Vivienda 4 (2_dcha)'
Fachada ventilada con placas de piedra natural		3.68	14.72	0.25	-41.0	0.6	V	E(90)	0.32	5.0
Fachada ventilada con placas de piedra natural		4.03	14.72	0.25	-44.8	0.6	V	N(0)	0.92	4.7
Tabique de una hoja, con trasdosado en una cara		4.54	18.33	0.49	-41.0					Hacia 'Zona no habitable 2'
Tabique de una hoja con trasdosado en ambas caras		14.84	25.53	0.28	1.6					Desde 'Vivienda 1 (1_izq)'
Forjado unidireccional		16.07	134.91	0.35	-216.5					Hacia 'Zona no habitable 1'
					-302.2	-1042.6*				67.6

## Vivienda 3 (2\_izq)

Fachada ventilada con placas de piedra natural		4.07	14.72	0.25	-48.8	0.6	V	S(180)	0.87	21.5
Medianería de dos hojas de fábrica		31.84	90.13							
Fachada ventilada con placas de piedra natural		1.26	14.72	0.25	-15.2	0.6	V	S(180)	0.96	7.4
Tabique PYL 78/600(48) LM		85.92	12.88							
Tabique PYL 78/600(48) LM		30.99	22.48							
Tabique de una hoja, con trasdosado en una cara		0.85	18.25	0.02	-1.0					
Forjado unidireccional		48.70	67.56	0.38	-58.6					Hacia 'Vivienda 1 (1_izq)'
Forjado unidireccional		67.50	16.89	0.38	5.2					Desde 'Vivienda 5 (3_izq)'
Fachada ventilada con placas de piedra natural		5.03	14.72	0.25	-60.4	0.6	V	N(0)	0.92	5.9
Forjado unidireccional		18.80	71.65	0.80	-47.3					Hacia 'Vivienda 1 (1_izq)'
Fachada ventilada con placas de piedra natural		4.38	14.72	0.25	-52.6	0.6	V	N(0)	0.88	4.9
Fachada ventilada con placas de piedra natural		4.26	14.72	0.25	-51.1	0.6	V	S(180)	0.82	21.1
Tabique de una hoja, con trasdosado en una cara		17.06	34.81	0.48	-27.9					Hacia 'Zona habitable 1'
Tabique de una hoja, con trasdosado en una cara		2.40	18.25	0.49	-25.4					Hacia 'Zona no habitable 2'
Tabique PYL 78/600(48) LM		30.98	12.94							
Tabique de una hoja, con trasdosado en una cara		8.02	18.33	0.02	-9.6					
Forjado unidireccional		22.70	132.89	0.40	-28.8					Hacia 'Vivienda 1 (1_izq)'
Forjado unidireccional		22.70	17.09	0.40	1.9					Desde 'Vivienda 5 (3_izq)'
Fachada ventilada con placas de piedra natural		4.18	14.72	0.25	-50.2	0.6	V	N(0)	1.00	5.4
Fachada ventilada con placas de piedra natural		3.97	14.72	0.25	-47.6	0.6	V	O(-90)	0.34	5.9
Tabique de una hoja con trasdosado en ambas caras		15.19	25.53	0.28	-0.2					Hacia 'Vivienda 4 (2_dcha)'
Tabique de una hoja, con trasdosado en una cara		4.55	18.33	0.49	-48.1					Hacia 'Zona no habitable 2'
					-336.6	-229.1*				72.1

## Vivienda 4 (2\_dcha)

Fachada ventilada con placas de piedra natural		1.27	14.72	0.25	-15.2	0.6	V	S(180)	0.96	7.4
Medianería de dos hojas de fábrica		32.02	90.13							
Fachada ventilada con placas de piedra natural		4.04	14.72	0.25	-48.5	0.6	V	S(180)	0.87	21.4
Tabique PYL 78/600(48) LM		31.03	22.48							
Tabique de una hoja, con trasdosado en una cara		0.85	18.25	0.02	-1.0					
Tabique PYL 78/600(48) LM		86.25	12.88							
Forjado unidireccional		48.57	67.56	0.38	-65.5					Hacia 'Vivienda 2 (1_dcha)'
Forjado unidireccional		67.65	16.89	0.38	7.3					Desde 'Vivienda 6 (3_dcha)'

# Justificación del cumplimiento de la exigencia básica HE 1: Limitación de demanda energética

	Tipo	S (m <sup>2</sup> )	c (kJ/ (m <sup>2</sup> ·K))	U (W/ (m <sup>2</sup> ·K))	âQ <sub>e</sub> (kWh /año)	a	I. (°)	O. (°)	F <sub>sh,o</sub>	âQ <sub>cal</sub> (kWh /año)
Fachada ventilada con placas de piedra natural		4.38	14.72	0.25	-52.5	0.6	V	N(0)	0.88	4.9
Forjado unidireccional		19.08	71.65	0.80	-53.9	Hacia 'Vivienda 2 (1_dcha)'				
Fachada ventilada con placas de piedra natural		5.01	14.72	0.25	-60.1	0.6	V	N(0)	0.92	5.9
Fachada ventilada con placas de piedra natural		4.28	14.72	0.25	-51.3	0.6	V	S(180)	0.82	21.2
Tabique de una hoja, con trasdosado en una cara		17.06	34.81	0.48	-27.6	Hacia 'Zona habitable 1'				
Tabique de una hoja, con trasdosado en una cara		2.40	18.25	0.49	-25.3	Hacia 'Zona no habitable 2'				
Tabique de una hoja, con trasdosado en una cara		7.97	18.33	0.02	-9.6					
Tabique PVL 78/600(48) LM		31.03	12.94							
Forjado unidireccional		22.65	132.89	0.40	-32.2	Hacia 'Vivienda 2 (1_dcha)'				
Forjado unidireccional		22.65	17.09	0.40	2.6	Desde 'Vivienda 6 (3_dcha)'				
Fachada ventilada con placas de piedra natural		3.80	14.72	0.25	-45.6	0.6	V	E(90)	0.35	5.7
Fachada ventilada con placas de piedra natural		4.17	14.72	0.25	-50.1	0.6	V	N(0)	1.00	5.4
Tabique de una hoja con trasdosado en ambas caras		15.19	25.53	0.28	0.2	Desde 'Vivienda 3 (2_izq)'				
Tabique de una hoja, con trasdosado en una cara		4.59	18.33	0.49	-48.4	Hacia 'Zona no habitable 2'				
					-333.8	-242.9*				71.8

## Vivienda 5 (3\_izq)

Fachada ventilada con placas de piedra natural		4.07	14.72	0.25	-49.1	0.6	V	S(180)	0.87	21.5
Medianería de dos hojas de fábrica		31.84	90.13							
Fachada ventilada con placas de piedra natural		1.26	14.72	0.25	-15.2	0.6	V	S(180)	0.96	7.3
Tabique PVL 78/600(48) LM		85.92	12.88							
Tabique PVL 78/600(48) LM		30.99	22.48							
Tabique de una hoja, con trasdosado en una cara		0.85	18.25	0.02	-1.0					
Forjado unidireccional		67.50	67.56	0.38	-5.2	Hacia 'Vivienda 3 (2_izq)'				
Forjado unidireccional		54.74	16.89	0.38	-31.4	Hacia 'Vivienda 7 (4_izq)'				
Forjado unidireccional		22.81	17.09	0.40	-13.8	Hacia 'Vivienda 7 (4_izq)'				
Fachada ventilada con placas de piedra natural		5.03	14.72	0.25	-60.6	0.6	V	N(0)	0.92	5.9
Forjado unidireccional		10.60	16.73	0.23	-3.8	Hacia 'Vivienda 7 (4_izq)'				
Fachada ventilada con placas de piedra natural		4.38	14.72	0.25	-52.9	0.6	V	N(0)	0.88	4.9
Fachada ventilada con placas de piedra natural		4.32	14.72	0.25	-52.0	0.6	V	S(180)	0.82	21.4
Tabique de una hoja, con trasdosado en una cara		17.06	34.81	0.48	-29.4	Hacia 'Zona habitable 1'				
Tabique de una hoja, con trasdosado en una cara		2.40	18.25	0.49	-25.6	Hacia 'Zona no habitable 2'				
Tabique PVL 78/600(48) LM		30.98	12.94							
Tabique de una hoja, con trasdosado en una cara		8.02	18.33	0.02	-9.7					
Forjado unidireccional		22.70	132.89	0.40	-1.9	Hacia 'Vivienda 3 (2_izq)'				
Fachada ventilada con placas de piedra natural		4.18	14.72	0.25	-50.5	0.6	V	N(0)	1.00	5.4
Fachada ventilada con placas de piedra natural		3.97	14.72	0.25	-47.9	0.6	V	O(-90)	0.34	5.9
Tabique de una hoja con trasdosado en ambas caras		15.19	25.53	0.28	0.2	Desde 'Vivienda 6 (3_dcha)'				
Tabique de una hoja, con trasdosado en una cara		4.55	18.33	0.49	-48.6	Hacia 'Zona no habitable 2'				
					-338.8	-159.5*				72.4

## Vivienda 6 (3\_dcha)

Fachada ventilada con placas de piedra natural		1.27	14.72	0.25	-15.3	0.6	V	S(180)	0.96	7.4
Medianería de dos hojas de fábrica		32.02	90.13							

## Justificación del cumplimiento de la exigencia básica HE 1: Limitación de demanda energética

	Tipo	S (m <sup>2</sup> )	c (kJ/ (m <sup>2</sup> ·K))	U (W/ (m <sup>2</sup> ·K))	âQ <sub>e</sub> (kWh /año)	a	I. (°)	O. (°)	F <sub>sh,o</sub>	âQ <sub>cal</sub> (kWh /año)
Fachada ventilada con placas de piedra natural		4.04	14.72	0.25	-48.8	0.6	V	S(180)	0.87	21.4
Tabique PYL 78/600(48) LM		31.03	22.48							
Tabique de una hoja, con trasdosado en una cara		0.85	18.25	0.02	-1.0					
Tabique PYL 78/600(48) LM		86.25	12.88							
Forjado unidireccional		67.65	67.56	0.38	-7.3					Hacia 'Vivienda 4 (2_dcha)'
Forjado unidireccional		54.87	16.89	0.38	-27.4					Hacia 'Vivienda 8 (4_dcha)'
Forjado unidireccional		22.80	17.09	0.40	-12.0					Hacia 'Vivienda 8 (4_dcha)'
Fachada ventilada con placas de piedra natural		4.38	14.72	0.25	-52.8	0.6	V	N(0)	0.88	4.9
Fachada ventilada con placas de piedra natural		5.01	14.72	0.25	-60.4	0.6	V	N(0)	0.92	5.9
Forjado unidireccional		10.69	16.73	0.23	-3.3					Hacia 'Vivienda 8 (4_dcha)'
Fachada ventilada con placas de piedra natural		4.28	14.72	0.25	-51.6	0.6	V	S(180)	0.82	21.2
Tabique de una hoja, con trasdosado en una cara		2.40	18.25	0.49	-25.6					Hacia 'Zona no habitable 2'
Tabique de una hoja, con trasdosado en una cara		17.06	34.81	0.48	-29.7					Hacia 'Zona habitable 1'
Tabique de una hoja, con trasdosado en una cara		7.97	18.33	0.02	-9.6					
Tabique PYL 78/600(48) LM		31.03	12.94							
Forjado unidireccional		22.65	132.89	0.40	-2.6					Hacia 'Vivienda 4 (2_dcha)'
Fachada ventilada con placas de piedra natural		3.80	14.72	0.25	-45.8	0.6	V	E(90)	0.35	5.8
Fachada ventilada con placas de piedra natural		4.17	14.72	0.25	-50.4	0.6	V	N(0)	1.00	5.4
Tabique de una hoja con trasdosado en ambas caras		15.19	25.53	0.28	-0.2					Hacia 'Vivienda 5 (3_izq)'
Tabique de una hoja, con trasdosado en una cara		4.59	18.33	0.49	-49.0					Hacia 'Zona no habitable 2'
					-335.8	-157.0*				71.9

### Vivienda 7 (4\_izq)

Fachada ventilada con placas de piedra natural		9.10	14.72	0.25	-108.4	0.6	V	N(0)	1.00	11.7
Fachada ventilada con placas de piedra natural		27.55	14.72	0.25	-328.2	0.6	V	O(-90.01)	0.30	35.8
Fachada ventilada con placas de piedra natural		5.49	14.72	0.25	-65.4	0.6	V	E(90)	0.30	7.2
Tabique PYL 78/600(48) LM		35.29	22.48							
Tabique PYL 78/600(48) LM		62.38	12.88							
Forjado unidireccional		4.74	73.01	0.35	-80.6	0.6	H		0.12	6.0
Forjado unidireccional		10.60	71.43	0.23	3.8					Desde 'Vivienda 5 (3_izq)'
Forjado unidireccional		70.04	17.09							
Cubierta plana transitable, no ventilada, con solado fijo, impermeabilización mediante láminas asfálticas. (Forjado unidireccional)		18.51	16.69	0.19	-169.2	0.6	H		0.12	12.4
Fachada ventilada con placas de piedra natural		4.11	14.72	0.25	-48.9	0.6	V	N(0)	0.84	4.4
Forjado unidireccional		54.74	67.56	0.38	31.4					Desde 'Vivienda 5 (3_izq)'
Fachada ventilada con placas de piedra natural		2.54	14.72	0.25	-30.3	0.6	V	O(-89.95)	0.30	3.3
Tabique de una hoja, con trasdosado en una cara		32.25	34.81	0.48	-44.8					Hacia 'Zona habitable 1'
Tabique de una hoja, con trasdosado en una cara		4.54	18.25	0.49	-46.9					Hacia 'Zona no habitable 2'
Tabique de una hoja, con trasdosado en una cara		4.21	18.25	0.05	-11.0					
Fachada ventilada con placas de piedra natural		1.30	14.72	0.25	-15.6	0.6	V	S(180)	0.96	7.6
Fachada ventilada con placas de piedra natural		8.52	14.72	0.25	-101.5	0.6	V	S(180)	0.93	47.9
Fachada ventilada con placas de piedra natural		7.07	14.72	0.25	-84.2	0.6	V	O(-90.03)	0.30	9.2
Tabique PYL 78/600(48) LM		35.29	12.94							
Tabique de una hoja, con trasdosado en una cara		4.71	18.33	0.05	-12.3					

# Justificación del cumplimiento de la exigencia básica HE 1: Limitación de demanda energética

	Tipo	S (m <sup>2</sup> )	c (kJ/ (m <sup>2</sup> ·K))	U (W/ (m <sup>2</sup> ·K))	âQ <sub>e</sub> (kWh /año)	a	I. (°)	O. (°)	F <sub>sho</sub>	âQ <sub>cal</sub> (kWh /año)
Tabique PYL 78/600(48) LM		6.68	22.54							
Forjado unidireccional		22.81	132.89	0.40	13.8					
Fachada ventilada con placas de piedra natural		4.13	14.72	0.25	-49.2	0.6	V	O(-90.29)	0.30	5.4
Tabique de una hoja con trasdosado en ambas caras		15.34	25.53	0.28	1.0					
Tabique de una hoja, con trasdosado en una cara		2.34	18.33	0.49	-24.1					
Fachada ventilada con placas de piedra natural		7.61	14.72	0.25	-90.6	0.6	V	S(180)	0.25	11.5
Fachada ventilada con placas de piedra natural		4.99	14.72	0.25	-59.4	0.6	V	N(0.07)	0.87	5.6
Fachada ventilada con placas de piedra natural		6.72	14.72	0.25	-80.1	0.6	V	N(0)	0.92	7.9
Fachada ventilada con placas de piedra natural		14.08	14.72	0.25	-167.8	0.6	V	O(-90)	1.00	61.3
Fachada ventilada con placas de piedra natural		12.21	14.72	0.25	-145.5	0.6	V	O(-90)	1.00	53.2
Tabique de una hoja, con trasdosado en una cara		8.55	46.22	0.49	-84.9					
Tabique de una hoja con trasdosado en ambas caras		6.03	16.87	0.28	0.4					
Tabique de una hoja, con trasdosado en una cara		10.38	18.25	0.06	-32.2					
Forjado unidireccional		70.04	105.07							
Cub.I. Teja Losa 15 (Forjado unidireccional)		47.66	166.83	0.34	-795.0	0.6	16	S(180)	0.12	65.9
Cub.I. Teja Losa 15 (Forjado unidireccional)		30.25	166.83	0.34	-504.5	0.6	12	N(0)	0.13	33.3
					-2979.9	-150.4*				389.6

## Vivienda 8 (4\_dcha)

Fachada ventilada con placas de piedra natural		9.18	14.72	0.25	-109.9	0.6	V	N(0)	1.00	11.8
Fachada ventilada con placas de piedra natural		3.96	14.72	0.25	-47.4	0.6	V	E(90)	0.30	5.2
Tabique de una hoja con trasdosado en ambas caras		15.34	25.53	0.28	-1.0					
Tabique de una hoja, con trasdosado en una cara		2.37	18.33	0.49	-24.7					
Tabique PYL 78/600(48) LM		35.41	12.94							
Forjado unidireccional		22.79	132.89	0.40	12.0					
Forjado unidireccional		69.85	17.09							
Cubierta plana transitable, no ventilada, con solado fijo, impermeabilización mediante láminas asfálticas. (Forjado unidireccional)		18.68	16.69	0.19	-171.6	0.6	H		0.12	12.5
Fachada ventilada con placas de piedra natural		4.19	14.72	0.25	-50.2	0.6	V	N(0)	0.84	4.5
Tabique PYL 78/600(48) LM		62.77	12.88							
Tabique PYL 78/600(48) LM		35.41	22.48							
Forjado unidireccional		54.87	67.56	0.38	27.4					
Fachada ventilada con placas de piedra natural		14.31	14.72	0.25	-171.3	0.6	V	E(90.03)	1.00	61.2
Fachada ventilada con placas de piedra natural		5.22	14.72	0.25	-62.6	0.6	V	O(-90.26)	0.30	6.8
Forjado unidireccional		10.69	71.43	0.23	3.3					
Forjado unidireccional		4.54	73.01	0.35	-77.7	0.6	H		0.12	5.7
Tabique de una hoja, con trasdosado en una cara		4.68	18.33	0.05	-12.3					
Tabique PYL 78/600(48) LM		6.65	22.54							
Fachada ventilada con placas de piedra natural		7.07	14.72	0.25	-84.7	0.6	V	E(89.95)	1.00	30.2
Fachada ventilada con placas de piedra natural		2.54	14.72	0.25	-30.4	0.6	V	E(90.22)	1.00	10.9
Tabique de una hoja, con trasdosado en una cara		32.25	34.81	0.48	-48.3					
Tabique de una hoja, con trasdosado en una cara		4.18	18.25	0.05	-11.0					
Tabique de una hoja, con trasdosado en una cara		4.54	18.25	0.49	-47.4					
Fachada ventilada con placas de piedra natural		8.51	14.72	0.25	-101.8	0.6	V	S(180)	0.93	47.9

# Justificación del cumplimiento de la exigencia básica HE 1: Limitación de demanda energética

	Tipo	S (m <sup>2</sup> )	c (kJ/ (m <sup>2</sup> ·K))	U (W/ (m <sup>2</sup> ·K))	âQ <sub>e</sub> (kWh /año)	a	I. (°)	O. (°)	F <sub>sh,o</sub>	âQ <sub>cal</sub> (kWh /año)
Fachada ventilada con placas de piedra natural		1.30	14.72	0.25	-15.6	0.6	V	S(180)	0.96	7.6
Fachada ventilada con placas de piedra natural		13.15	14.72	0.25	-157.4	0.6	V	E(89.95)	1.00	56.2
Fachada ventilada con placas de piedra natural		7.59	14.72	0.25	-90.9	0.6	V	S(180)	0.25	11.5
Fachada ventilada con placas de piedra natural		12.21	14.72	0.25	-146.2	0.6	V	E(90)	1.00	52.3
Fachada ventilada con placas de piedra natural		14.05	14.72	0.25	-168.2	0.6	V	E(89.99)	1.00	60.1
Fachada ventilada con placas de piedra natural		6.71	14.72	0.25	-80.3	0.6	V	N(0.07)	0.91	7.9
Fachada ventilada con placas de piedra natural		4.99	14.72	0.25	-59.8	0.6	V	N(0.07)	0.87	5.6
Tabique de una hoja, con trasdosado en una cara		8.59	46.22	0.49	-86.2	Hacia 'Zona no habitable 4 (Asc_1)'				
Tabique de una hoja, con trasdosado en una cara		10.33	18.25	0.06	-32.2					
Tabique de una hoja con trasdosado en ambas caras		6.03	16.87	0.28	-0.4	Hacia 'Vivienda 7 (4_izq)'				
Forjado unidireccional		69.86	105.07							
Cub.I. Teja Losa 15 (Forjado unidireccional)		47.53	166.83	0.34	-796.7	0.6	16	S(180)	0.12	65.7
Cub.I. Teja Losa 15 (Forjado unidireccional)		30.15	166.83	0.34	-505.3	0.6	12	N(0)	0.13	33.2
					-2983.3	-165.3*				496.7

## Zona no habitable 1

Fachada ventilada con placas de piedra natural		4.87	14.72	0.25	-8.2	0.6	V	S(180)	0.91	26.7
Medianería de hoja de fábrica		192.56	114.28							
Tabique de una hoja, con trasdosado en una cara		51.50	86.24	0.49	953.7	Desde 'Zona habitable 1'				
Tabique de una hoja, para revestir		236.68	80.84							
Tabique de una hoja, para revestir		20.85	56.17	2.00	814.7	Desde 'Zona no habitable 2'				
Losa de cimentación		246.93	196.94	0.20	-329.3					
Forjado unidireccional		34.82	144.49	0.34	454.2	Desde 'Vivienda 1 (1_izq)'				
Forjado unidireccional		49.98	144.49	0.34	644.8	Desde 'Vivienda 2 (1_dcha)'				
Forjado unidireccional		21.91	144.81	0.35	298.5	Desde 'Vivienda 1 (1_izq)'				
Forjado unidireccional		16.07	144.81	0.35	216.5	Desde 'Vivienda 2 (1_dcha)'				
Cubierta plana transitable, no ventilada, con solado fijo, impermeabilización mediante láminas asfálticas. (Forjado unidireccional)		78.94	141.03	0.25	-136.6	0.6	H		0.12	71.3
Forjado unidireccional		5.82	168.29	0.36	79.5	Desde 'Vivienda 2 (1_dcha)'				
Forjado unidireccional		14.57	167.98	0.34	190.7	Desde 'Vivienda 2 (1_dcha)'				
Fachada ventilada con placas de piedra natural		10.32	14.72	0.25	-17.3	0.6	V	S(180)	0.97	60.5
Tabique de una hoja, para revestir		18.11	80.84	1.95	190.2	Desde 'Zona no habitable 3 (Basuras)'				
Forjado unidireccional		9.70	167.98	0.34	128.3	Desde 'Vivienda 1 (1_izq)'				
					-491.4	+3971.1*				158.6

## Zona no habitable 2

Tabique de una hoja, para revestir		20.85	77.93	2.00	-814.7	Hacia 'Zona no habitable 1'				
Tabique de una hoja, con trasdosado en una cara		5.38	86.09	0.49	48.0	Desde 'Zona habitable 1'				
Losa de cimentación		3.06	280.97	0.20	-15.6					
Tabique de una hoja, para revestir		12.39	63.32	1.94	436.3	Desde 'Zona habitable 1'				
Tabique de una hoja, con trasdosado en una cara		2.38	86.09	0.49	21.5	Desde 'Vivienda 2 (1_dcha)'				
Tabique de una hoja, con trasdosado en una cara		4.54	93.69	0.49	41.0	Desde 'Vivienda 2 (1_dcha)'				
Tabique de una hoja, con trasdosado en una cara		4.50	93.69	0.49	41.5	Desde 'Vivienda 1 (1_izq)'				
Tabique de una hoja, con trasdosado en una cara		2.38	86.09	0.49	21.9	Desde 'Vivienda 1 (1_izq)'				



# Justificación del cumplimiento de la exigencia básica HE 1: Limitación de demanda energética

	Tipo	S (m <sup>2</sup> )	c (kJ/ (m <sup>2</sup> ·K))	U (W/ (m <sup>2</sup> ·K))	âQ <sub>e</sub> (kWh /año)	a	I. (°)	O. (°)	F <sub>sh,o</sub>	âQ <sub>cal</sub> (kWh /año)
Tabique de una hoja, con trasdosado en una cara		4.59	93.69	0.49	48.4					
Tabique de una hoja, con trasdosado en una cara		4.55	93.69	0.49	48.1					
Tabique de una hoja, con trasdosado en una cara		2.40	86.09	0.49	25.4					
Tabique de una hoja, con trasdosado en una cara		2.40	86.09	0.49	25.3					
Tabique de una hoja, con trasdosado en una cara		4.59	93.69	0.49	49.0					
Tabique de una hoja, con trasdosado en una cara		4.55	93.69	0.49	48.6					
Tabique de una hoja, con trasdosado en una cara		2.40	86.09	0.49	25.6					
Tabique de una hoja, con trasdosado en una cara		2.40	86.09	0.49	25.6					
Tabique de una hoja, con trasdosado en una cara		2.34	93.69	0.49	24.1					
Tabique de una hoja, con trasdosado en una cara		4.54	86.09	0.49	46.9					
Tabique de una hoja, con trasdosado en una cara		4.54	86.09	0.49	47.4					
Tabique de una hoja, con trasdosado en una cara		2.37	93.69	0.49	24.7					
Forjado unidireccional		2.88	168.28	0.36	0.8					
					-15.6	+235.4*				0

## Zona habitable 1

Fachada ventilada con placas de piedra natural		3.23	14.72	0.25	-36.3	0.6	V	O(-90)	0.54	7.7
Fachada ventilada con placas de piedra natural		8.67	14.72	0.25	-97.5	0.6	V	S(180)	0.96	50.4
Fachada ventilada con placas de piedra natural		3.19	14.72	0.25	-35.9	0.6	V	S(180)	0.52	10.1
Tabique de una hoja, con trasdosado en una cara		51.50	46.22	0.49	-953.7					
Tabique de una hoja, con trasdosado en una cara		5.38	18.25	0.49	-48.0					
Tabique de una hoja, con trasdosado en una cara		2.52	46.22	0.49	-40.0					
Losa de cimentación		25.25	133.21	0.14	-156.4					
Forjado unidireccional		7.22	16.79							
Forjado unidireccional		9.18	16.73	0.23	-0.6					
Fachada ventilada con placas de piedra natural		6.68	14.72	0.25	-75.1	0.6	V	S(180)	0.95	38.6
Tabique de una hoja, con trasdosado en una cara		16.63	86.37	0.48	1.8					
Tabique de una hoja, para revestir		12.39	59.00	1.94	-436.3					
Tabique de una hoja, con trasdosado en una cara		16.63	86.37	0.48	4.8					
Forjado unidireccional		7.22	133.36							
Forjado unidireccional		29.14	17.09							
Tabique de una hoja, con trasdosado en una cara		17.06	86.37	0.48	27.6					
Tabique de una hoja, con trasdosado en una cara		17.06	86.37	0.48	27.9					
Forjado unidireccional		29.14	132.89							
Fachada ventilada con placas de piedra natural		3.40	14.72	0.25	-38.3	0.6	V	S(180)	0.97	20.0
Tabique de una hoja, con trasdosado en una cara		17.06	86.37	0.48	29.7					
Tabique de una hoja, con trasdosado en una cara		17.06	86.37	0.48	29.4					
Fachada ventilada con placas de piedra natural		3.40	14.72	0.25	-38.3	0.6	V	S(180)	0.93	19.1
Tabique de una hoja, con trasdosado en una cara		32.25	86.37	0.48	44.8					
Tabique de una hoja, con trasdosado en una cara		32.25	86.37	0.48	48.3					
Fachada ventilada con placas de piedra natural		2.55	14.72	0.25	-28.7	0.6	V	S(180)	0.25	3.9
Tabique de una hoja, con trasdosado en una cara		4.55	46.22	0.49	-38.8					
Cub.I. Teja Losa 15 (Forjado unidireccional)		15.00	166.83	0.34	-236.1	0.6	16	S(180)	0.12	20.7
					-742.5	-1303.2*				170.4

# Justificación del cumplimiento de la exigencia básica HE 1: Limitación de demanda energética

	Tipo	S (m <sup>2</sup> )	c (kJ/ (m <sup>2</sup> ·K))	U (W/ (m <sup>2</sup> ·K))	âQ <sub>e</sub> (kWh /año)	a	I. (°)	O. (°)	F <sub>sh,o</sub>	âQ <sub>sol</sub> (kWh /año)
<b>Zona no habitable 3 (Basuras)</b>										
Medianería de hoja de fábrica		7.26	114.28							
Fachada ventilada con placas de piedra natural		16.56	14.72	0.25	-50.3	0.6	V	S(180)	0.93	93.5
Fachada ventilada con placas de piedra natural		3.27	14.72	0.25	-9.9	0.6	V	E(90)	0.59	8.2
Tabique de una hoja, con trasdosado en una cara		2.52	86.24	0.49	40.0	Desde 'Zona habitable 1'				
Tabique de una hoja, para revestir		18.11	80.84	1.95	-190.2	Hacia 'Zona no habitable 1'				
Losa de cimentación		9.18	196.94	0.20	-22.2					
Forjado unidireccional		9.04	144.49	0.34	101.3	Desde 'Vivienda 1 (1_izq)'				
					-82.5	-48.9*				101.7
<b>Zona no habitable 4 (Asc_1)</b>										
Tabique de una hoja, con trasdosado en una cara		8.55	86.24	0.49	84.9	Desde 'Vivienda 7 (4_izq)'				
Tabique de una hoja, con trasdosado en una cara		4.55	86.24	0.49	38.8	Desde 'Zona habitable 1'				
Tabique de una hoja, con trasdosado en una cara		8.59	86.24	0.49	86.2	Desde 'Vivienda 8 (4_dcha)'				
Forjado unidireccional		2.88	106.87	0.36	-0.8	Hacia 'Zona no habitable 2'				
Cub.I. Teja Losa 15 (Forjado unidireccional)		3.01	166.83	0.34	-27.8	0.6	12	N(0)	0.13	3.3
					-27.8	+209.1*				3.3

donde:























- S: Superficie del elemento.
- c: Capacidad calorífica por superficie del elemento.
- U: Transmitancia térmica del elemento.
- Q<sub>e</sub>: Calor intercambiado con el ambiente exterior, a través del elemento, a lo largo del año.
- \*: Calor intercambiado con otras zonas del modelo térmico, a través del elemento, a lo largo del año.
- a: Coeficiente de absorción solar (absortividad) de la superficie opaca.
- I.: Inclinación de la superficie (elevación).
- O.: Orientación de la superficie (azimut respecto al norte).
- F<sub>sh,o</sub>: Valor medio anual del factor de corrección de sombra por obstáculos exteriores.
- Q<sub>sol</sub>: Ganancia solar acumulada a lo largo del año.

## 2.3.2.- Composición constructiva. Elementos constructivos ligeros.

La transmisión de calor al exterior a través de los elementos constructivos ligeros que forman la envolvente térmica de las zonas habitables del edificio (-19.4 kWh/(m<sup>2</sup>·año)) supone el 48.9% de la transmisión térmica total a través de dicha envolvente (-39.6 kWh/(m<sup>2</sup>·año)).

	Tipo	S (m <sup>2</sup> )	U <sub>g</sub> (W/ (m <sup>2</sup> ·K))	F <sub>f</sub> (%)	U <sub>f</sub> (W/ (m <sup>2</sup> ·K))	âQ <sub>e</sub> (kWh /año)	g <sub>gl</sub>	a	I. (°)	O. (°)	F <sub>sh,gl</sub>	F <sub>sh,o</sub>	âQ <sub>sol</sub> (kWh /año)
<b>Vivienda 1 (1_izq)</b>													
Doble acristalamiento Aislaglas "UNIÓN VIDRIERA ARAGONESA", 6/6/10		2.25	3.20	0.38	2.20	-285.1	0.73	0.4	V	S(180)	0.39	0.89	465.9
Doble acristalamiento Aislaglas "UNIÓN VIDRIERA ARAGONESA", 6/6/10		1.80	3.20	0.42	2.20	-224.8	0.73	0.4	V	N(0)	1.00	0.94	309.4
Doble acristalamiento Aislaglas "UNIÓN VIDRIERA ARAGONESA", 6/6/10		1.80	3.20	0.42	2.20	-224.8	0.73	0.4	V	N(0)	1.00	0.92	302.9
Doble acristalamiento Aislaglas "UNIÓN VIDRIERA ARAGONESA", 6/6/10		5.00	3.20	0.28	2.20	-654.6	0.73	0.4	V	S(180)	0.67	0.91	2021.5
Puerta de entrada a la vivienda, de madera		1.68		1.00	1.90	-1.9	Hacia 'Zona habitable 1'						
Doble acristalamiento Aislaglas "UNIÓN VIDRIERA ARAGONESA", 6/6/10		2.40	3.20	0.36	2.20	-305.5	0.73	0.4	V	N(0)	1.00	0.97	465.2
Doble acristalamiento Aislaglas "UNIÓN VIDRIERA ARAGONESA", 6/6/10		1.47	3.20	0.46	2.20	-180.5	0.73	0.4	V	O(-90)	0.76	0.47	204.1

# Justificación del cumplimiento de la exigencia básica HE 1: Limitación de demanda energética

Tipo	S (m <sup>2</sup> )	U <sub>g</sub> (W/ (m <sup>2</sup> ·K))	F <sub>F</sub> (%)	U <sub>i</sub> (W/ (m <sup>2</sup> ·K))	âQ <sub>e</sub> (kWh /año)	g <sub>gl</sub>	a	l. (°)	O. (°)	F <sub>sh,gl</sub>	F <sub>sh,o</sub>	âQ <sub>col</sub> (kWh /año)	
-1875.4 -1.9* 3769.0													
<b>Vivienda 2 (1_dcha)</b>													
Doble acristalamiento Aislaglas "UNIÓN VIDRIERA ARAGONESA", 6/6/10		2.25	3.20	0.38	2.20	-282.8	0.73	0.4	V	S(180)	0.39	0.89	465.6
Doble acristalamiento Aislaglas "UNIÓN VIDRIERA ARAGONESA", 6/6/10		1.80	3.20	0.42	2.20	-222.9	0.73	0.4	V	N(0)	1.00	0.92	302.8
Doble acristalamiento Aislaglas "UNIÓN VIDRIERA ARAGONESA", 6/6/10		1.80	3.20	0.42	2.20	-222.9	0.73	0.4	V	N(0)	1.00	0.93	308.7
Doble acristalamiento Aislaglas "UNIÓN VIDRIERA ARAGONESA", 6/6/10		5.00	3.20	0.28	2.20	-649.2	0.73	0.4	V	S(180)	0.67	0.91	2021.6
Puerta de entrada a la vivienda, de madera		1.68		1.00	1.90	-0.7	Hacia 'Zona habitable 1'						
Doble acristalamiento Aislaglas "UNIÓN VIDRIERA ARAGONESA", 6/6/10		1.47	3.20	0.46	2.20	-179.1	0.73	0.4	V	E(90)	0.76	0.47	201.4
Doble acristalamiento Aislaglas "UNIÓN VIDRIERA ARAGONESA", 6/6/10		2.40	3.20	0.36	2.20	-303.0	0.73	0.4	V	N(0)	1.00	0.97	465.2
-1859.9 -0.7* 3765.4													
<b>Vivienda 3 (2_izq)</b>													
Doble acristalamiento Aislaglas "UNIÓN VIDRIERA ARAGONESA", 6/6/10		2.25	3.20	0.38	2.20	-302.7	0.73	0.4	V	S(180)	0.39	0.89	465.7
Doble acristalamiento Aislaglas "UNIÓN VIDRIERA ARAGONESA", 6/6/10		1.80	3.20	0.42	2.20	-238.6	0.73	0.4	V	N(0)	1.00	0.95	315.1
Doble acristalamiento Aislaglas "UNIÓN VIDRIERA ARAGONESA", 6/6/10		1.80	3.20	0.42	2.20	-238.6	0.73	0.4	V	N(0)	1.00	0.93	308.3
Doble acristalamiento Aislaglas "UNIÓN VIDRIERA ARAGONESA", 6/6/10		5.00	3.20	0.28	2.20	-695.0	0.73	0.4	V	S(180)	0.67	0.91	2021.5
Puerta de entrada a la vivienda, de madera		1.68		1.00	1.90	-10.7	Hacia 'Zona habitable 1'						
Doble acristalamiento Aislaglas "UNIÓN VIDRIERA ARAGONESA", 6/6/10		2.40	3.20	0.36	2.20	-324.4	0.73	0.4	V	N(0)	1.00	1.00	480.8
Doble acristalamiento Aislaglas "UNIÓN VIDRIERA ARAGONESA", 6/6/10		1.47	3.20	0.46	2.20	-191.7	0.73	0.4	V	O(-90)	0.76	0.50	213.9
-1991.1 -10.7* 3805.2													
<b>Vivienda 4 (2_dcha)</b>													
Doble acristalamiento Aislaglas "UNIÓN VIDRIERA ARAGONESA", 6/6/10		2.25	3.20	0.38	2.20	-302.5	0.73	0.4	V	S(180)	0.39	0.89	465.7
Doble acristalamiento Aislaglas "UNIÓN VIDRIERA ARAGONESA", 6/6/10		1.80	3.20	0.42	2.20	-238.5	0.73	0.4	V	N(0)	1.00	0.93	308.5
Doble acristalamiento Aislaglas "UNIÓN VIDRIERA ARAGONESA", 6/6/10		1.80	3.20	0.42	2.20	-238.5	0.73	0.4	V	N(0)	1.00	0.95	314.4
Doble acristalamiento Aislaglas "UNIÓN VIDRIERA ARAGONESA", 6/6/10		5.00	3.20	0.28	2.20	-694.5	0.73	0.4	V	S(180)	0.67	0.91	2021.9
Puerta de entrada a la vivienda, de madera		1.68		1.00	1.90	-10.6	Hacia 'Zona habitable 1'						
Doble acristalamiento Aislaglas "UNIÓN VIDRIERA ARAGONESA", 6/6/10		1.47	3.20	0.46	2.20	-191.5	0.73	0.4	V	E(90)	0.76	0.50	211.0
Doble acristalamiento Aislaglas "UNIÓN VIDRIERA ARAGONESA", 6/6/10		2.40	3.20	0.36	2.20	-324.2	0.73	0.4	V	N(0)	1.00	1.00	480.8
-1989.6 -10.6* 3802.1													
<b>Vivienda 5 (3_izq)</b>													
Doble acristalamiento Aislaglas "UNIÓN VIDRIERA ARAGONESA", 6/6/10		2.25	3.20	0.38	2.20	-303.9	0.73	0.4	V	S(180)	0.39	0.89	465.2
Doble acristalamiento Aislaglas "UNIÓN VIDRIERA ARAGONESA", 6/6/10		1.80	3.20	0.42	2.20	-239.6	0.73	0.4	V	N(0)	1.00	0.95	315.1

# Justificación del cumplimiento de la exigencia básica HE 1: Limitación de demanda energética

	Tipo	S (m <sup>2</sup> )	U <sub>g</sub> (W/ (m <sup>2</sup> ·K))	F <sub>F</sub> (%)	U <sub>i</sub> (W/ (m <sup>2</sup> ·K))	āQ <sub>e</sub> (kWh /año)	g <sub>gl</sub>	a	l. (°)	O. (°)	F <sub>sh,gl</sub>	F <sub>sh,o</sub>	āQ <sub>col</sub> (kWh /año)
Doble acristalamiento Aislaglas "UNIÓN VIDRIERA ARAGONESA", 6/6/10		1.80	3.20	0.42	2.20	-239.6	0.73	0.4	V	N(0)	1.00	0.93	308.4
Doble acristalamiento Aislaglas "UNIÓN VIDRIERA ARAGONESA", 6/6/10		5.00	3.20	0.28	2.20	-697.7	0.73	0.4	V	S(180)	0.67	0.91	2020.8
Puerta de entrada a la vivienda, de madera		1.68		1.00	1.90	-11.3	Hacia 'Zona habitable 1'						
Doble acristalamiento Aislaglas "UNIÓN VIDRIERA ARAGONESA", 6/6/10		2.40	3.20	0.36	2.20	-325.6	0.73	0.4	V	N(0)	1.00	1.00	480.8
Doble acristalamiento Aislaglas "UNIÓN VIDRIERA ARAGONESA", 6/6/10		1.47	3.20	0.46	2.20	-192.4	0.73	0.4	V	O(-90)	0.76	0.50	214.1
						-1998.8	-11.3*					3804.3	

## Vivienda 6 (3\_dcha)

Doble acristalamiento Aislaglas "UNIÓN VIDRIERA ARAGONESA", 6/6/10		2.25	3.20	0.38	2.20	-304.1	0.73	0.4	V	S(180)	0.39	0.89	465.7
Doble acristalamiento Aislaglas "UNIÓN VIDRIERA ARAGONESA", 6/6/10		1.80	3.20	0.42	2.20	-239.8	0.73	0.4	V	N(0)	1.00	0.93	308.6
Doble acristalamiento Aislaglas "UNIÓN VIDRIERA ARAGONESA", 6/6/10		1.80	3.20	0.42	2.20	-239.8	0.73	0.4	V	N(0)	1.00	0.95	314.4
Doble acristalamiento Aislaglas "UNIÓN VIDRIERA ARAGONESA", 6/6/10		5.00	3.20	0.28	2.20	-698.2	0.73	0.4	V	S(180)	0.67	0.91	2021.9
Puerta de entrada a la vivienda, de madera		1.68		1.00	1.90	-11.4	Hacia 'Zona habitable 1'						
Doble acristalamiento Aislaglas "UNIÓN VIDRIERA ARAGONESA", 6/6/10		1.47	3.20	0.46	2.20	-192.6	0.73	0.4	V	E(90)	0.76	0.50	211.3
Doble acristalamiento Aislaglas "UNIÓN VIDRIERA ARAGONESA", 6/6/10		2.40	3.20	0.36	2.20	-325.9	0.73	0.4	V	N(0)	1.00	1.00	480.8
						-2000.3	-11.4*					3802.5	







## Vivienda 7 (4\_izq)

Doble acristalamiento Aislaglas "UNIÓN VIDRIERA ARAGONESA", 6/6/10		4.20	3.20	0.39	2.20	-557.1	0.73	0.4	V	N(0)	1.00	1.00	811.3
Doble acristalamiento Aislaglas "UNIÓN VIDRIERA ARAGONESA", 6/6/10		1.80	3.20	0.42	2.20	-236.1	0.73	0.4	V	N(0)	1.00	0.92	302.7
Puerta de entrada a la vivienda, de madera		1.68		1.00	1.90	-9.1	Hacia 'Zona habitable 1'						
Doble acristalamiento Aislaglas "UNIÓN VIDRIERA ARAGONESA", 6/6/10		2.25	3.20	0.38	2.20	-299.5	0.73	0.4	V	S(180)	0.39	0.96	500.1
Doble acristalamiento Aislaglas "UNIÓN VIDRIERA ARAGONESA", 6/6/10		5.00	3.20	0.28	2.20	-687.6	0.73	0.4	V	S(180)	0.67	0.97	2155.7
Doble acristalamiento Aislaglas "UNIÓN VIDRIERA ARAGONESA", 6/6/10		1.47	3.20	0.46	2.20	-189.7	0.73	0.4	V	O(-90.29)	0.76	0.44	191.6
Doble acristalamiento Aislaglas "UNIÓN VIDRIERA ARAGONESA", 6/6/10		2.40	3.20	0.36	2.20	-321.0	0.73	0.4	V	N(0.07)	1.00	0.93	448.2
Doble acristalamiento Aislaglas "UNIÓN VIDRIERA ARAGONESA", 6/6/10		2.40	3.20	0.36	2.20	-321.0	0.73	0.4	V	N(0)	1.00	0.97	465.1
Doble acristalamiento Aislaglas "UNIÓN VIDRIERA ARAGONESA", 6/6/10		1.47	3.20	0.46	2.20	-189.7	0.73	0.4	V	N(0)	1.00	0.93	232.9
Acrilamiento (U = 1.80 W/(m <sup>2</sup> K) / Factor solar = 0.30)		1.75	1.80			-148.5	0.30	0.6	16	S(180)	1.00	0.31	304.4
						-2950.0	-9.1*					5411.9	



## Vivienda 8 (4\_dcha)

Doble acristalamiento Aislaglas "UNIÓN VIDRIERA ARAGONESA", 6/6/10		4.20	3.20	0.39	2.20	-559.7	0.73	0.4	V	N(0)	1.00	1.00	811.3
Doble acristalamiento Aislaglas "UNIÓN VIDRIERA ARAGONESA", 6/6/10		1.47	3.20	0.46	2.20	-190.6	0.73	0.4	V	E(90)	0.76	0.45	191.8
Doble acristalamiento Aislaglas "UNIÓN VIDRIERA ARAGONESA", 6/6/10		1.80	3.20	0.42	2.20	-237.2	0.73	0.4	V	N(0)	1.00	0.92	302.7

# Justificación del cumplimiento de la exigencia básica HE 1: Limitación de demanda energética

	Tipo	S (m <sup>2</sup> )	U <sub>g</sub> (W/ (m <sup>2</sup> ·K))	F <sub>F</sub> (%)	U <sub>t</sub> (W/ (m <sup>2</sup> ·K))	âQ <sub>e</sub> (kWh /año)	g <sub>gl</sub>	a	I. (°)	O. (°)	F <sub>sh,gl</sub>	F <sub>sh,o</sub>	âQ <sub>col</sub> (kWh /año)
Puerta de entrada a la vivienda, de madera		1.68		1.00	1.90	-9.8							
Doble acristalamiento Aislaglas "UNIÓN VIDRIERA ARAGONESA", 6/6/10		5.00	3.20	0.28	2.20	-690.9	0.73	0.4	V	S(180)	0.67	0.97	2155.9
Doble acristalamiento Aislaglas "UNIÓN VIDRIERA ARAGONESA", 6/6/10		2.25	3.20	0.38	2.20	-300.9	0.73	0.4	V	S(180)	0.39	0.96	500.5
Doble acristalamiento Aislaglas "UNIÓN VIDRIERA ARAGONESA", 6/6/10		2.40	3.20	0.36	2.20	-322.5	0.73	0.4	V	N(0.07)	1.00	0.97	464.0
Doble acristalamiento Aislaglas "UNIÓN VIDRIERA ARAGONESA", 6/6/10		1.47	3.20	0.46	2.20	-190.6	0.73	0.4	V	N(0.07)	1.00	0.94	233.0
Doble acristalamiento Aislaglas "UNIÓN VIDRIERA ARAGONESA", 6/6/10		2.40	3.20	0.36	2.20	-322.5	0.73	0.4	V	N(0.07)	1.00	0.93	448.2
Acristalamiento (U = 1.80 W/(m <sup>2</sup> K) / Factor solar = 0.30)		1.75	1.80			-149.2	0.30	0.6	16	S(180)	1.00	0.31	304.4
						-2964.0							-9.8*
													5411.7

















## Zona no habitable 1

Puerta metálica		6.80		1.00	5.70	-251.1		0.6	V	S(180)	0.00	0.99	945.0
Puerta cortafuegos, de acero galvanizado		1.60		1.00	2.25	136.4							
						-251.1							+136.4*
													945.0

## Zona no habitable 2

Puerta metálica		8.13		1.00	5.70	843.1							
						0							+843.1*



## Zona habitable 1

Doble acristalamiento de seguridad (laminar) "UNIÓN VIDRIERA ARAGONESA", 4/6/laminar incoloro 4+4 laminar		2.31	3.20	0.20	5.70	-378.7	0.74	0.4	V	S(180)	0.56	0.63	622.6
Puerta metálica		8.13		1.00	5.70	-843.1							Hacia 'Zona no habitable 2'
Puerta cortafuegos, de acero galvanizado		1.60		1.00	2.25	-136.4							Hacia 'Zona no habitable 1'
Puerta cortafuegos, de acero galvanizado		1.60		1.00	2.25	-116.9							Hacia 'Zona no habitable 3 (Basuras)'
Doble acristalamiento Aislaglas "UNIÓN VIDRIERA ARAGONESA", 6/6/10		4.00	3.20	0.12	2.20	-544.9	0.73	0.4	V	S(180)	0.56	0.97	1736.4
Puerta de entrada a la vivienda, de madera		1.68		1.00	1.90	0.7							Desde 'Vivienda 2 (1_dcha)'
Puerta de entrada a la vivienda, de madera		1.68		1.00	1.90	1.9							Desde 'Vivienda 1 (1_izq)'
Puerta de entrada a la vivienda, de madera		1.68		1.00	1.90	10.6							Desde 'Vivienda 4 (2_dcha)'
Puerta de entrada a la vivienda, de madera		1.68		1.00	1.90	10.7							Desde 'Vivienda 3 (2_izq)'
Doble acristalamiento Aislaglas "UNIÓN VIDRIERA ARAGONESA", 6/6/10		2.00	3.20	0.12	2.20	-272.5	0.73	0.4	V	S(180)	0.56	0.97	872.5
Puerta de entrada a la vivienda, de madera		1.68		1.00	1.90	11.4							Desde 'Vivienda 6 (3_dcha)'
Puerta de entrada a la vivienda, de madera		1.68		1.00	1.90	11.3							Desde 'Vivienda 5 (3_izq)'
Doble acristalamiento Aislaglas "UNIÓN VIDRIERA ARAGONESA", 6/6/10		2.00	3.20	0.12	2.20	-272.5	0.73	0.4	V	S(180)	0.56	0.97	870.0
Puerta de entrada a la vivienda, de madera		1.68		1.00	1.90	9.8							Desde 'Vivienda 8 (4_dcha)'
Puerta de entrada a la vivienda, de madera		1.68		1.00	1.90	9.1							Desde 'Vivienda 7 (4_izq)'
Puerta cortafuegos, de acero galvanizado		1.60		1.00	2.25	-62.7							Hacia 'Zona no habitable 4 (Asc_1)'
						-1468.5							-1093.5*
													4101.5

## Zona no habitable 3 (Basuras)

Puerta cortafuegos, de acero galvanizado		1.60		1.00	2.25	-42.8		0.6	V	S(180)	0.00	0.99	88.1
--	---	------	--	------	------	-------	--	-----	---	--------	------	------	------

# Justificación del cumplimiento de la exigencia básica HE 1: Limitación de demanda energética

	Tipo	S (m <sup>2</sup> )	U <sub>g</sub> (W/ (m <sup>2</sup> ·K))	F <sub>f</sub> (%)	U <sub>i</sub> (W/ (m <sup>2</sup> ·K))	āQ <sub>e</sub> (kWh /año)	g <sub>gl</sub>	a	I. (°)	O. (°)	F <sub>sh,gl</sub>	F <sub>sh,o</sub>	āQ <sub>sol</sub> (kWh /año)
Puerta cortafuegos, de acero galvanizado		1.60		1.00	2.25	116.9					Desde 'Zona habitable 1'		
						-42.8							+116.9*
88.1													
<hr/>													
Zona no habitable 4 (Asc_1)													
Puerta cortafuegos, de acero galvanizado		1.60		1.00	2.25	62.7					Desde 'Zona habitable 1'		
						0							+62.7*







donde:







- S: Superficie del elemento.
- U<sub>g</sub>: Transmitancia térmica de la parte translúcida.
- F<sub>f</sub>: Fracción de parte opaca del elemento ligero.
- U<sub>i</sub>: Transmitancia térmica de la parte opaca.
- Q<sub>e</sub>: Calor intercambiado con el ambiente exterior, a través del elemento, a lo largo del año.
- \*: Calor intercambiado con otras zonas del modelo térmico, a través del elemento, a lo largo del año.
- g<sub>gl</sub>: Transmitancia total de energía solar de la parte transparente.
- a: Coeficiente de absorción solar (absortividad) de la parte opaca del elemento ligero.
- I.: Inclinación de la superficie (elevación).
- O.: Orientación de la superficie (azimut respecto al norte).
- F<sub>sh,gl</sub>: Valor medio anual del factor reductor de sombreadamiento para dispositivos de sombra móviles.
- F<sub>sh,o</sub>: Valor medio anual del factor de corrección de sombra por obstáculos exteriores.
- Q<sub>sol</sub>: Ganancia solar acumulada a lo largo del año.

## 2.3.3.- Composición constructiva. Puentes térmicos.



























La transmisión de calor a través de los puentes térmicos incluidos en la envolvente térmica de las zonas habitables del edificio (-11.4 kWh/(m<sup>2</sup>·año)) supone el 28.9% de la transmisión térmica total a través de dicha envolvente (-39.6 kWh/(m<sup>2</sup>·año)).

Tomando como referencia únicamente la transmisión térmica a través de los elementos pesados y puentes térmicos de la envolvente habitable del edificio (-20.2 kWh/(m<sup>2</sup>·año)), el porcentaje debido a los puentes térmicos es el 56.6%.

	Tipo	L (m)	y (W/(m·K))	āQ <sub>e</sub> (kWh /año)
<hr/>				
Vivienda 1 (1_izq)				
Contorno de ventana		32.20	0.190	-280.7
Fachada en esquina vertical saliente		9.66	0.080	-35.4
Encuentro saliente de fachada con suelo exterior		16.84	0.430	-332.3
Forjado entre pisos		27.52	0.420	-530.2
Fachada en esquina vertical entrante		4.79	-0.150	32.9
Fachada en esquina vertical saliente		0.38	0.150	-2.6
				-1148.3
<hr/>				

<hr/>				
Vivienda 2 (1_dcha)				
Contorno de ventana		32.20	0.190	-278.0
Fachada en esquina vertical saliente		9.66	0.080	-35.1
Encuentro saliente de fachada con suelo exterior		17.49	0.430	-341.8
Forjado entre pisos		27.51	0.420	-524.9
Fachada en esquina vertical entrante		4.79	-0.150	32.6
Fachada en esquina vertical saliente		0.38	0.150	-2.6
				-1149.8

# Justificación del cumplimiento de la exigencia básica HE 1: Limitación de demanda energética

	Tipo	L (m)	y (W/(m·K))	$\dot{a}Q_e$ (kWh /año)
<b>Vivienda 3 (2_izq)</b>				
Contorno de ventana		32.20	0.190	-299.7
Fachada en esquina vertical saliente		9.18	0.080	-36.0
Forjado entre pisos		38.72	0.420	-796.5
Forjado entre pisos		3.96	-0.050	9.7
Fachada en esquina vertical entrante		4.61	-0.150	33.8
				-1088.6
<b>Vivienda 4 (2_dcha)</b>				
Contorno de ventana		32.20	0.190	-299.4
Fachada en esquina vertical saliente		10.35	0.080	-40.5
Forjado entre pisos		38.70	0.420	-795.5
Fachada en esquina vertical entrante		4.61	-0.150	33.8
Forjado entre pisos		4.02	-0.050	9.8
				-1091.8
<b>Vivienda 5 (3_izq)</b>				
Contorno de ventana		32.20	0.190	-301.0
Fachada en esquina vertical saliente		9.18	0.080	-36.1
Forjado entre pisos		39.67	0.420	-819.9
Fachada en esquina vertical entrante		4.61	-0.150	34.0
				-1123.0
<b>Vivienda 6 (3_dcha)</b>				
Contorno de ventana		32.20	0.190	-301.3
Fachada en esquina vertical saliente		10.35	0.080	-40.8
Forjado entre pisos		39.69	0.420	-820.8
Fachada en esquina vertical entrante		4.61	-0.150	34.0
				-1128.8
<b>Vivienda 7 (4_izq)</b>				
Contorno de ventana		30.00	0.190	-277.2
Fachada en esquina vertical saliente		19.51	0.080	-75.9
Fachada en esquina vertical entrante		9.15	-0.150	66.8
Forjado entre pisos		45.81	0.420	-935.7
Encuentro de fachada con cubierta		39.18	0.430	-819.3
Fachada en esquina vertical saliente		0.35	0.150	-2.5
				-2043.9
<b>Vivienda 8 (4_dcha)</b>				
Contorno de ventana		30.00	0.190	-278.6
Fachada en esquina vertical entrante		9.15	-0.150	67.1

# Justificación del cumplimiento de la exigencia básica HE 1: Limitación de demanda energética

	Tipo	L (m)	y (W/(m·K))	$\dot{Q}_v$ (kWh/año)
Fachada en esquina vertical saliente		19.51	0.080	-76.3
Forjado entre pisos		45.83	0.420	-940.7
Encuentro de fachada con cubierta		39.05	0.430	-820.7
Fachada en esquina vertical saliente		0.35	0.150	-2.6
				-2051.7

Zona habitable 1				
Fachada en esquina vertical saliente		28.85	0.080	-105.9
Fachada en esquina vertical entrante		3.44	-0.150	23.7
Unión de solera con pared exterior		20.28	0.140	-130.3
Contorno de ventana		24.00	0.190	-209.2
Encuentro de fachada con cubierta		2.06	0.430	-40.7
				-462.4

donde:

- L: Longitud del puente térmico lineal.
- y: Transmitancia térmica lineal del puente térmico.
- n: Número de puentes térmicos puntuales.
- X: Transmitancia térmica puntual del puente térmico.
- $Q_v$ : Calor intercambiado en el puente térmico a lo largo del año.

## 2.4.- Procedimiento de cálculo de la demanda energética.

El procedimiento de cálculo empleado consiste en la simulación anual de un modelo zonal del edificio con acoplamiento térmico entre zonas, mediante el método completo simplificado en base horaria de tipo dinámico descrito en UNE-EN ISO 13790:2011, cuya implementación ha sido validada mediante los tests descritos en la Norma EN 15265:2007 (Energy performance of buildings - Calculation of energy needs for space heating and cooling using dynamic methods - General criteria and validation procedures). Este procedimiento de cálculo utiliza un modelo equivalente de resistencia-capacitancia (R-C) de tres nodos en base horaria. Este modelo hace una distinción entre la temperatura del aire interior y la temperatura media radiante de las superficies interiores (revestimiento de la zona del edificio), permitiendo su uso en comprobaciones de confort térmico, y aumentando la exactitud de la consideración de las partes radiantes y convectivas de las ganancias solares, luminosas e internas.

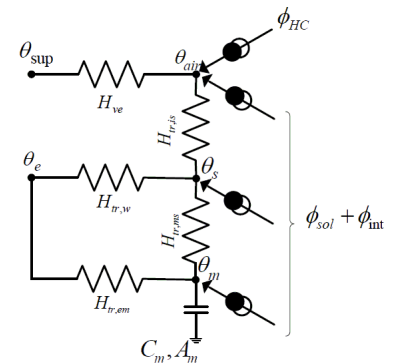

La metodología cumple con los requisitos impuestos en el capítulo 5 de CTE DB HE 1, al considerar los siguientes aspectos:

- el diseño, emplazamiento y orientación del edificio;
- la evolución hora a hora en régimen transitorio de los procesos térmicos;
- el acoplamiento térmico entre zonas adyacentes del edificio a distintas temperaturas;
- las solicitaciones interiores, solicitaciones exteriores y condiciones operacionales especificadas en los apartados 4.1 y 4.2 de CTE DB HE 1, teniendo en cuenta la posibilidad de que los espacios se comporten en oscilación libre;
- las ganancias y pérdidas de energía por conducción a través de la envolvente térmica del edificio, compuesta por los cerramientos opacos, los huecos y los puentes térmicos, con consideración de la inercia térmica de los materiales;
- las ganancias y pérdidas producidas por la radiación solar al atravesar los elementos transparentes o semitransparentes y las relacionadas con el calentamiento de elementos opacos de la envolvente térmica, considerando las propiedades de los elementos, su orientación e inclinación y las sombras propias del edificio u otros obstáculos que puedan bloquear dicha radiación;



## Justificación del cumplimiento de la exigencia básica HE 1: Limitación de demanda energética

- las ganancias y pérdidas de energía producidas por el intercambio de aire con el exterior debido a ventilación e infiltraciones teniendo en cuenta las exigencias de calidad del aire de los distintos espacios y las estrategias de control empleadas.

Permitiendo, además, la obtención separada de la demanda energética de calefacción y de refrigeración del edificio.